

# MAGNUSON

## SUPERCHARGERS

### Installation Instructions for: Intercooled Supercharger System 2010-2015 LS3/L99 Magnum PI Chevrolet Camaro



Step-by-step instructions for installing the best in supercharger systems.

**\* PREMIUM GASOLINE FUEL REQUIRED \***

**ATTENTION!**

**Your MAGNUSON SUPERCHARGER kit is sensitive to corrosion!**

**Use only the vehicle manufacturer recommended coolant for your engine in the intercooler system as well.**



Magnuson Superchargers  
1990 Knoll Drive, Bldg A, Ventura, CA. 93003  
(805) 642-8833  
magnusonsuperchargers.com

# INSTALLATION MANUAL

## Magnuson Supercharger GM 6.2L Engine 2010-2015 LS3/L99 Chevrolet Camaro

Please take a few moments to review this manual thoroughly before you begin work: Make a quick parts check to be certain your kit is complete (see shipper parts list in this package). If you discover shipping damage or shortage, please call your dealer immediately. Take a look at exactly what you are going to need in terms of tools, time, and experience. Review our limited warranty with care. When unpacking the supercharger kit **DO NOT** lift the supercharger assembly by the black plastic bypass actuator. This is pre-set from the factory and can be altered if used as a lifting point!

Caution: Relieve the fuel system pressure before servicing fuel system components in order to reduce the risk of fire and personal injury. After relieving the system pressure, a small amount of fuel may be released when servicing the fuel lines or connections. In order to reduce the risk of personal injury, cover the regulator and fuel line fittings with a shop towel before disconnecting. This will catch any fuel that may leak out. Place the towel in an approved container when the job is complete.

**This supercharger system requires the use of only premium gasoline fuel, 91 octane or better. It is NOT compatible with E85, Ethanol, or Flex fuels.**

Magnuson Superchargers recommend that you run a minimum of one (1) tank of premium fuel through your vehicle prior to installation of the system to prevent any possible damage that may occur due to running the supercharged engine on lower octane fuel. **DO NOT add octane booster to your vehicle.**

Magnuson Superchargers systems are designed for engines and vehicles in “GOOD” mechanical condition. Magnuson Superchargers recommend that a basic engine system “Health Check” be performed prior to the installation of this supercharger system. Be sure to check for any pending or actual OBDII codes and fix/repair any of the stock systems/components causing these codes. If there are codes prior to the installation they will be there after the installation.

Magnuson Superchargers also recommend the following services to be performed on your vehicle before starting and running the vehicle post supercharger system installation:

- Fuel and Air Filter change
  - Engine oil and oil filter change using the vehicle manufacturer’s specified products
- NOTE: It is VERY IMPORTANT to use the factory specified oil viscosity. The original equipment manufacturer has selected this grade of oil to work with your other engine systems such as hydraulic chain tensioners and variable cam controls. Deviation from this specification may cause these systems to fail or not function properly. Please refer to your owner’s manual for the recommended oil viscosity for your engine and application.

- On newer vehicles not requiring new spark plugs it is important to verify the spark plug air gap.

On older vehicles Magnuson Superchargers recommend these additional services to be performed:

- New spark plugs with the air gap set at the factory specifications OR new specifications if required by the installation manual.
- Engine coolant system pressure test, flush and refill.

**NOTE: YOU MUST USE THE GM SPECIFIED COOLANT MIXTURE!**

- Non “Magnuson Approved” calibrations or “tuning” will Void ALL warranties and CARB certification.

## Tools Required

Metric wrench set  
1/4" - 3/8" and 1/2" drive metric socket set with 22mm, 24mm and 27mm (Standard & Deep)  
3/8" and 1/2" drive foot pound and inch pound torque wrenches  
Phillips and flat head screwdrivers  
1/2" breaker bar  
Fuel line quick disconnect tools (included in kit)  
Small or angled 3/8" drill motor  
Hammer, and small drift punch  
Drain pan and funnel  
Hose cutters  
Hose clamp pliers  
Safety glasses  
Small pry bar  
Metric Allen socket set 3/8" drive  
Shop vacuum cleaner

### Helpful Tools:

Air or electric impact wrench  
Torque Angle Meter

## IMPORTANT

### NOTES:

- 1. For the purpose of these instructions, all references to left hand side or right hand side shall be interpreted as if being seated in the driver seat of the vehicle.**
- 2. It is IMPORTANT to utilize 91 Octane gasoline or better with your supercharger system. Before starting this installation, on an empty tank, fill your tank to full with 91 Octane gasoline or better.**
- 3. Never add Octane booster to your fuel. If you have used Octane Booster in the past, replace your spark plugs and check your O2 sensors before completing your supercharger install.**
- 4. Your supercharger system is sensitive to corrosion. Use only the OEM recommended coolant mixture for your supercharger system as well as your engine.**
- 5. Please remember to follow all safety rules that apply when working, including:**
  - Wear eye protection at all times**
  - Do not work on a hot engine**
  - Be careful around fuel – use shop towels to catch any spills and dispose of towels properly**

### Contact Information:

Magnuson Superchargers  
1990 Knoll Drive, Bldg A  
Ventura, CA 93003

Sales/Technical Support Line: (805) 642-8833  
Website: [www.magnusonsuperchargers.com](http://www.magnusonsuperchargers.com)  
Emails: [sales@magnusonsuperchargers.com](mailto:sales@magnusonsuperchargers.com)  
[support@magnusonsuperchargers.com](mailto:support@magnusonsuperchargers.com)

**Supercharger Drive belt = Gates# K061062**

# Table of Contents

<b>Section 1: Tuning Your Vehicle Computer, and Initial Steps</b>	<b>5</b>
<b>Section 2: Intake Plenum, PCV, EVAP, and Fuel Line Removal</b>	<b>8</b>
<b>Section 3: Coil Pack, and Manifold Removal</b>	<b>12</b>
<b>Section 4: Coolant Line, and Air Box Removal</b>	<b>16</b>
<b>Section 5: Crank Pulley Pinning</b>	<b>19</b>
<b>Section 6: Idler Pulley Replacement</b>	<b>22</b>
<b>Section 7: Valley Cover, Steam Pipe, &amp; Coil Bracket Replacement</b>	<b>24</b>
<b>Section 8: Wire Harness Extensions, and Intake Manifold Parts Removal</b>	<b>34</b>
<b>Section 9: Supercharger Preparation and Install</b>	<b>39</b>
<b>Section 10: Belt, Radiator, and Throttle Body Adapter Installation</b>	<b>47</b>
<b>Section 11: Hose Line, Electrical Connections and Throttle Body Install</b>	<b>49</b>
<b>Section 12: Front Fascia Removal, and Intercooler Pump Installation</b>	<b>54</b>
<b>Section 13: Low Temperature Radiator (LTR) Installation</b>	<b>61</b>
<b>Section 14: Body Panel Installation, and Final Inspection</b>	<b>71</b>

**\* PLEASE PAY ATTENTION TO THE STEPS IN THIS INSTRUCTION MANUAL. ENGINE DAMAGE CAN OCCUR IF YOU DO NOT FOLLOW THE INSTRUCTIONS.**

**NOTE:** For the purpose of these instructions all references to left or right side are assumed to be as indicated from a seated position in the driver's seat of the vehicle.

## Section 1: Tuning Your Vehicle Computer, and Initial Steps

1. If your kit has a provided handheld tuner follow the instructions in the provided pamphlet to install your tune. **WARNING: DO NOT BEGIN THE INSTALLATION BEFORE OBTAINING YOUR NEW CALIBRATION FILE. IN SOME CASES, ESPECIALLY WITH NEWER VEHICLES, THIS STEP CAN TAKE SEVERAL DAYS AND YOUR VEHICLE WILL BE IMMOBILIZED WHILE YOU WAIT FOR THE NEW CALIBRATION FILE.** Your handheld tuner may not match the one shown.
2. Your Intercooler system is sensitive to corrosion. It's very important to use the OEM recommended coolant mixture in your supercharger system as well.
3. Your system requires the use of minimum 91 Octane gasoline fuel. This system is not compatible with E85 fuel.



4. Open the trunk and lift up the floor mat. Unscrew the cap nut holding the floor panel in place and set the panel aside for later reinstall.

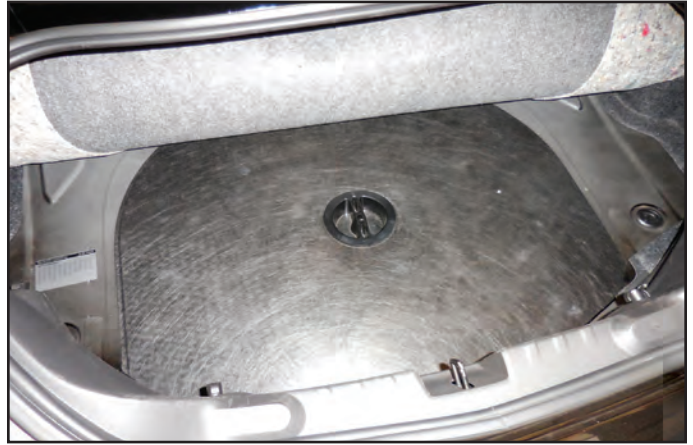

5. Remove the protective cover underneath the floor panel.



6. Your battery is now exposed. Disconnect the battery negative terminal using a 10 mm wrench. Cap or cover the terminal to protect against accidental contact with the battery post.



**Make sure your vehicle has cooled down before proceeding.**

7. Remove the radiator fill cap.



8. From below the vehicle on the left hand side, loosen the petcock drain to allow the radiator to release the coolant. Collect in a clean pan for refilling later on. Set aside in a safe place where it won't be contaminated. When draining is complete, tighten the petcock valve and replace the radiator cap.



9. Use a 13mm wrench to remove the strut tower brace, if equipped, at the suspension towers. There are two bolts on each side. This will not be reinstalled.



10. Disconnect the PCV tube at the oil separator if equipped.



11. Remove the oil fill cap, or the oil separator if equipped.



## Section 2: Intake Plenum, PCV, EVAP, and Fuel Line Removal

12. Lift up on the front edge of the engine cover to disconnect the cover from the mounting posts.



13. Replace the oil fill cap. If vehicle was equipped with oil-separator, cap or cover the fill neck. The separator will be installed in a later step.



14. Remove vacuum line release tab shown with a screwdriver, and disconnect the line.



15. Use an 8mm nut driver or flat head screwdriver to loosen the clamps holding the bellows to the air box, and the air supply plenum to the throttle body. Pull these connections free.





16. Lift up and pull the air supply plenum out of the engine compartment. Set aside.



17. Disconnect the EVAP tube looping over the throttle body from the right hand side of the engine to the rear of the left hand side of the throttle body.



18. Disconnect the other end of the tube at the EVAP Solenoid by pressing the white release tabs and pulling it free.



19. Disconnect the electrical plug on the EVAP Solenoid.

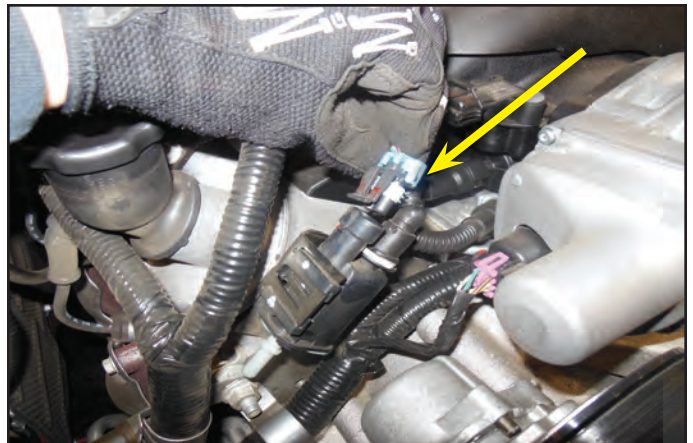

20. Disconnect the remaining tube from the EVAP Solenoid.



21. Use a 10 mm wrench to remove the nut holding the plastic bracket over the intake manifold at the back of the engine, and remove the bracket.



22. Use the supplied plastic fuel line removal tool to disconnect the EVAP connection next to the fuel line on the right hand side of the engine behind the heat shield. First, push the connection onto the hard line barb a bit, then press the fuel line removal tool into the fitting to release the retaining ring. Now pull the EVAP line off of the hard line barb.

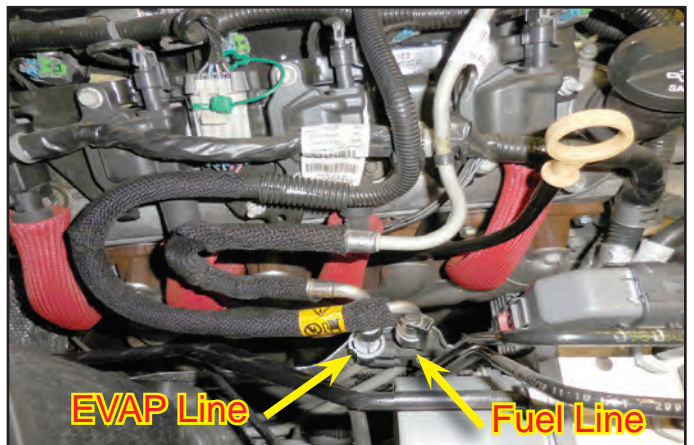

23. Remove the fuel tank cap to relieve residual pressure on the fuel system.



24. **Have some shop towels ready for fuel spillage. Wear safety glasses while removing the fuel line fittings.** Pry out on the safety clip to release the clip from the fuel line/hard line.

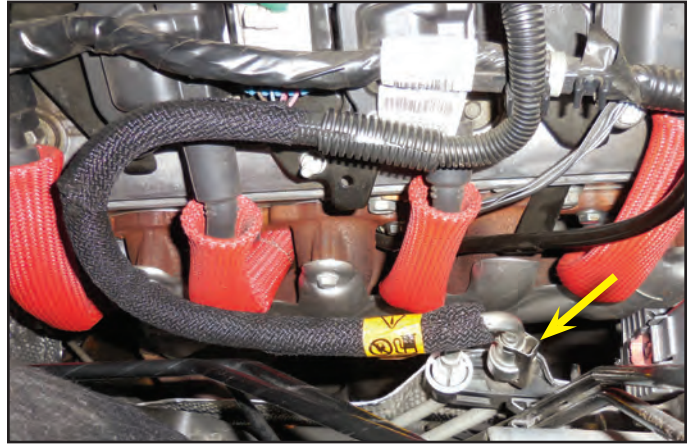

25. **Place a rag around the fuel line connection prior to removal. Have a cup on hand to catch any leaking fuel. The rag, and cup have been left out of this photo for better view of the connections.** Press the fitting onto the hard line barb, then press the provided fuel line removal tool into the connection to release the retaining ring.



26. Now the fuel line can be pulled free of the hard line barb. Place a cap over the fuel line, or improvise one with a section of fuel compatible hose and a plug. Dispose of fuel soaked shop towels in an appropriate manner.

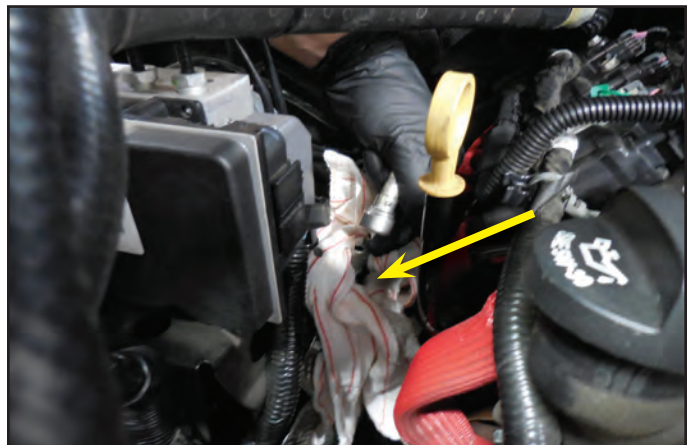

27. Replace the fuel fill cap.



### Section 3: Coil Pack, and Manifold Removal

28. Disconnect the MAP Sensor connection behind the throttle body on the right hand side of the engine.

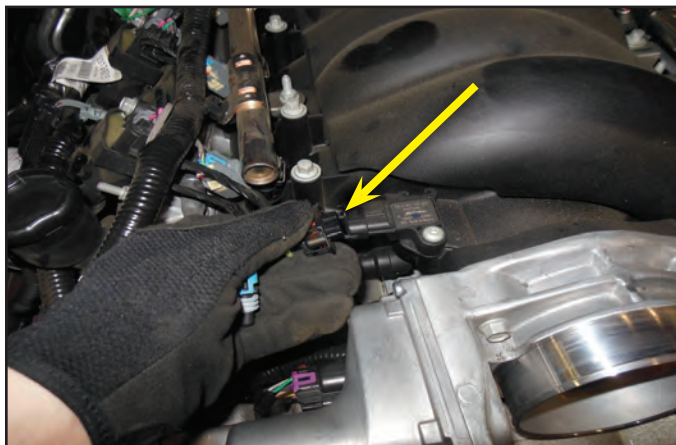

29. Disconnect the throttle control harness from the throttle body.



30. There is a short PCV tube running from below the intake manifold to a hose barb just below the MAP sensor. Disconnect this fitting. This will only be reused for LS3 engines.



31. Pull the green locking clip from the coil pack main harness connector on each side of the engine.



32. Press the release tab and pull the harness connector from the coil pack mounted connection.

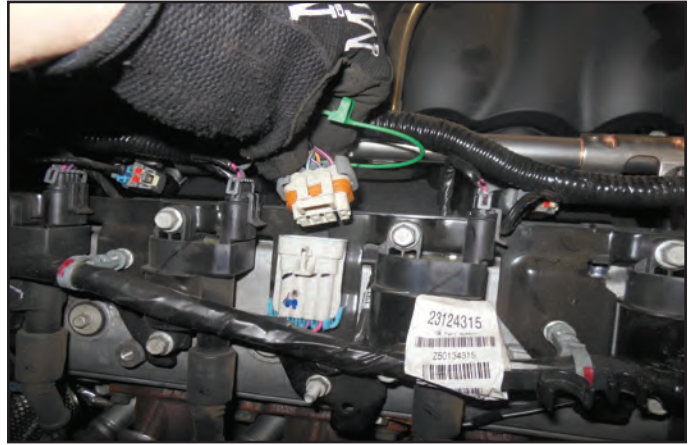

33. Pull the right side harness mounting clips from the coil pack mounting posts on the coil pack bracket.



34. Disconnect the plug wires from the coil packs on both sides of the engine.



35. Remove the eight coil pack wires.



36. Use a 10mm wrench to remove the harness mounting posts/coil pack mounting bracket screws holding the brackets to the valve cover on each side of the engine. There will be five screws per bracket.

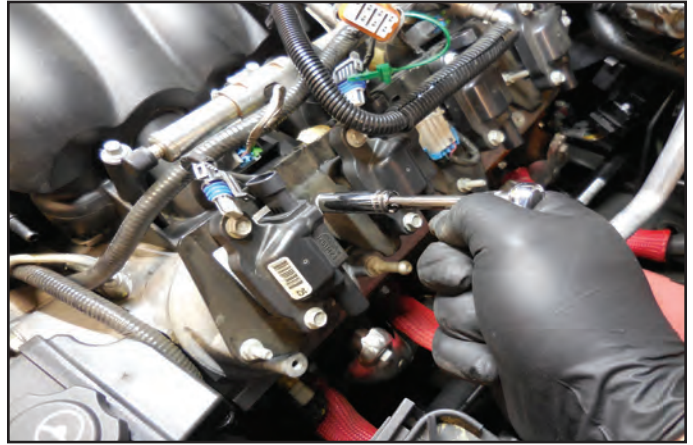

37. Remove the coil packs from the engine for modification and later re-installation.



38. Disconnect the injector plugs from the injectors on both sides of the engine. First pull out on the green locking tab then press the sides of the clip to release them from the injectors.

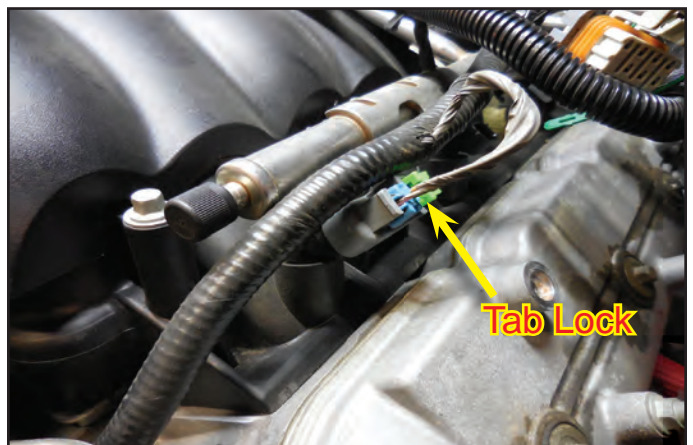

39. Use a pry tool to remove the injector harness mounting "trees" from the holes on the injector manifold mounting tabs.



40. At the back of the engine on the left hand side there may be a Vacuum Actuated Exhaust tube which reverses direction with a 90° fitting just after a 90° bend. Press the green locking tabs to release the tube from that connection if equipped.

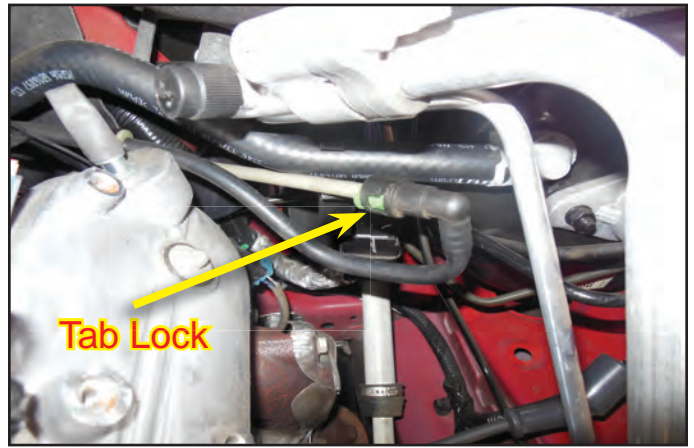

41. Pull the brake booster connection from the brake booster grommet at the back of the engine compartment on the left hand side.



42. Use a 10 mm socket to remove the ten bolts holding the intake manifold to the heads.

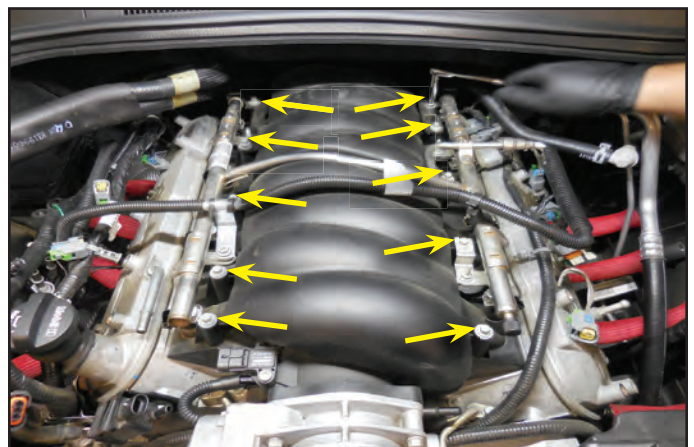

43. Have an assistant help you to carefully lift the OEM intake manifold from the engine. Set aside for parts removal to incorporate with your new supercharger installation.



44. First use a shop vacuum to remove any loose contaminants from around your heads, intake ports and valley cover area.



45. Now use a shop towel with denatured alcohol, or some other non-petroleum based solvent to clean around all the intake openings.



46. Use tape or shop towels to cover the intake ports.

**It's VERY important to not contaminate your work environment or allow any debris to fall into the exposed ports, engine damage CAN occur.**



## Section 4: Coolant Line, and Air Box Removal

47. In an earlier step you removed one end of a short looping tube from the intake manifold on the right hand side of the engine. The other end of this tube is now exposed. Release the locking tab and pull this tube off the valley cover hose barb. This hose will not be re-used.





48. **Note: Avoid spilling any coolant on the belts and pulleys. The smallest amount of coolant can cause the new belt to be noisy.** Place a rag down as shown to catch any coolant. Disconnect the hose from the coolant vent pipe on the left hand side, front of the engine. Disconnect the other end of the coolant vent pipe hose from the barb on the left hand side of the radiator fill cap.

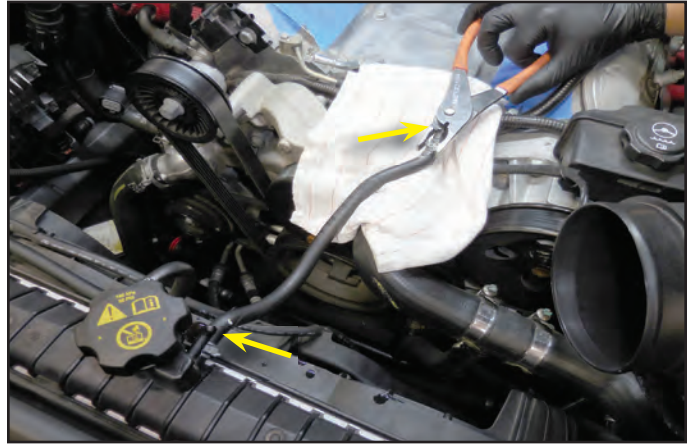

49. Pull up on the harness mounting rings that hold the harness to the water pump hose on the left side of the engine if equipped.



50. Disconnect the MAF sensor harness connection from the MAF Sensor on the OEM air box.



51. Remove the two nuts holding the air box with a 10 mm socket.



52. Remove the air box.



53. **It's VERY IMPORTANT to not get coolant on your engine pulleys. The smallest amount can cause "Belt squeaking".**

To minimize fluid mess, place shop towels below the water pump hose barb, remove the mounting clamp and pull the upper radiator hose from the water pump hose barb.



54. Also place towels below the radiator end of the upper radiator hose, remove the clamp and pull the radiator hose off the left hand side, upper radiator hose barb. If your car has an oil cooler hose attached with a "T" fitting then remove that hose at the lower connection shown with a green arrow.

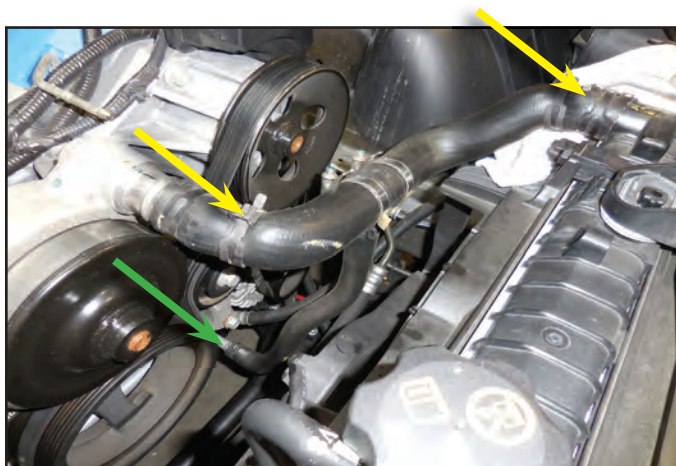

55. Disconnect the radiator fan control plug from the receptacle on the right hand side of the radiator.

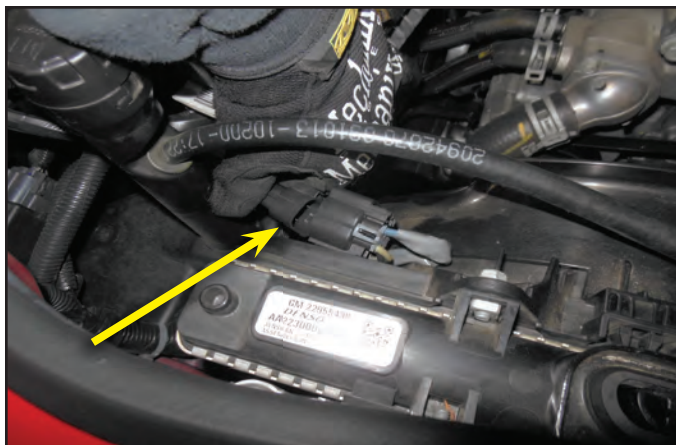

56. Use a 13 mm wrench to remove the radiator fan mounting screws from the radiator mounting tabs.



57. The radiator fan shroud should now be able to move somewhat freely. Remove the radiator fan shroud from the vehicle for later re-installation. You should be able to lift upwards on the shroud to remove from the engine bay.



## Section 5: Crank Pulley Pinning

58. Use a 24 mm socket and impact wrench to remove the main crank pulley mounting bolt. You may need to apply some heat to the bolt to aid in removal.



59. This is the pin drill guide and provided mounting bolt. The stepped side faces towards the crank to center with the pulley.



60. Replace the removed crank pulley mounting bolt with the provided drill guide and mounting bolt. It's easier if you have the holes of the drill guide oriented horizontally for visibility purposes. **Torque this down to 24 ft-lbs.**



61. Place a strip of visible tape around the top of the last step of the provided step-drill for visibility purposes. Use a drill motor to drill out the crank and pulley completely to the second step of the provided step drill for both holes. You can easily see when you have gone far enough when the visible tape touches the face of the key way guide.



62. Use compressed air to evacuate the particles from the new holes.

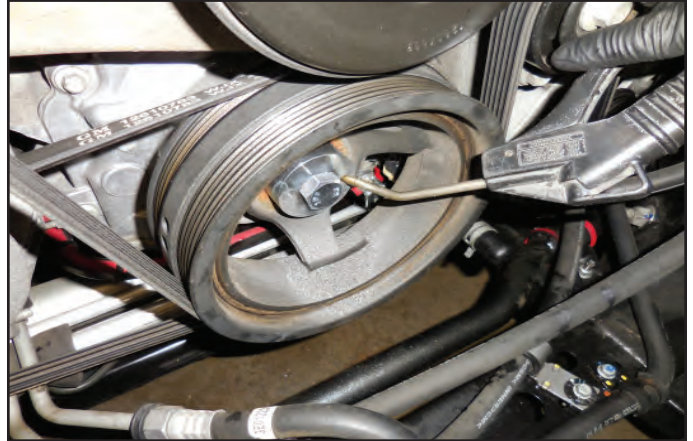

63. Vacuum out area to clear metal chips.



64. Install the reamer bit in your drill motor and ream out your holes. Once again use compressed air to remove debris from the two holes. Now remove the drill key way guide and mounting bolt using a 22mm socket.



65. Place two provided pins into the holes. Use a drift punch, or nail set to ensure that the two pins get completely into the holes.

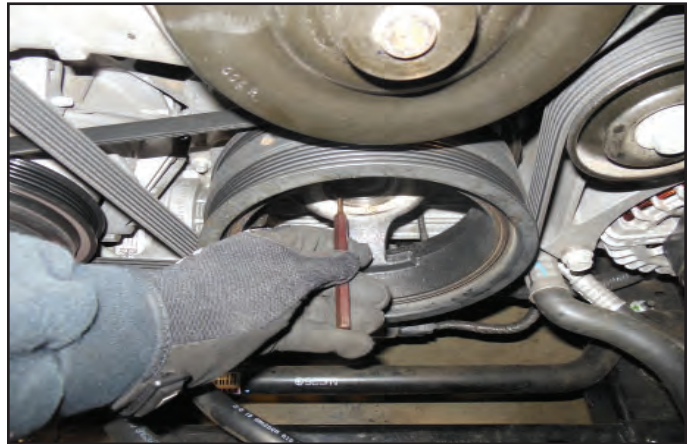

66. This picture shows that the pins are behind the surface where the pulley bolt will touch.

**Make sure the pins are below the contact surface for the harmonic balancer bolt.**



67. Install the new provided factory GM harmonic balancer bolt. Using a 24 mm socket, tighten the new harmonic balancer bolt according to the GM specifications.

- Tighten to 50 N-m (37 ft-lbs) using a torque wrench. Verify your torque wrench setting.**
- Tighten an additional 140° using a torque angle meter.**



## Section 6: Idler Pulley Replacement

68. Use a 15mm socket to spring the tensioner to allow the outer accessory drive belt to be removed.



69. Use a 15 mm socket to remove the two tensioner mounting bolts shown with arrows.



70. Remove the OEM tensioner assembly from the vehicle and set aside along with the fasteners from the previous step. The tensioner, and bolts will be reused.



71. Below and between the tensioner mounting bosses use a 10 mm socket to remove the indicated bolt. This will not be reused.



72. We will be using this vacated hole to mount the new tensioner assembly.

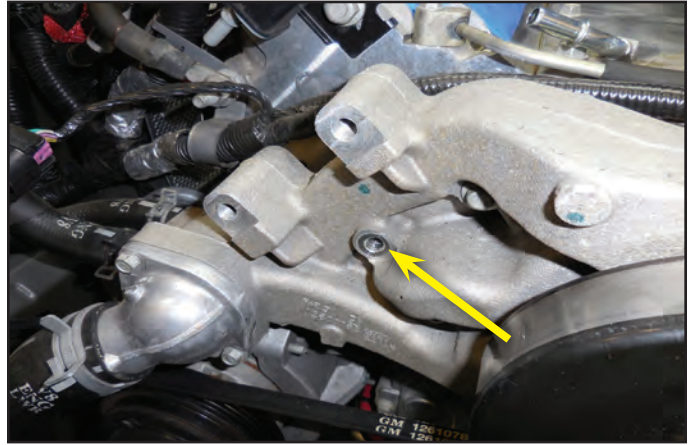

73. Use a 15 mm wrench to mount the new tensioner/idler pulley mounting bracket in the holes vacated using the two OEM bolts removed earlier. Use a 12 mm socket to secure the provided bolt below and between the removed tensioner mounting bolts.

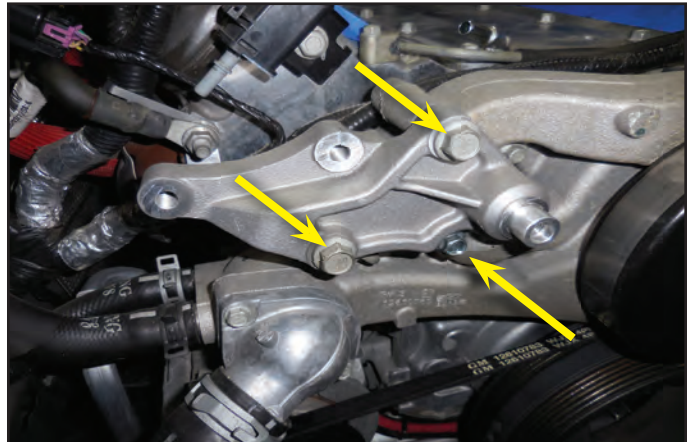

74. **Torque the two 15 mm hex head mounting bolts to 30 ft-lbs, and the 12 mm hex head mounting bolt to 18 ft-lbs.**



75. Re-mount the OEM tensioner to the new tensioner mounting bracket **torquing the two provided bolts to 30 ft-lbs with a 15 mm socket.**



76. Mount the provided Idler pulley with the side showing in the photo facing out away from the engine using the provided bolt to the boss between the crank pulley and the tensioner pulley.

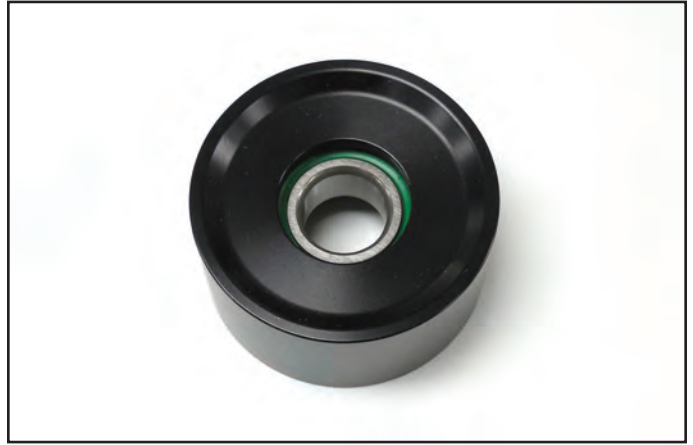

77. This photo shows the location for the provided idler pulley shown in the last step. **Torque the mounting bolt for the provided idler pulley to 30 ft-lbs.**

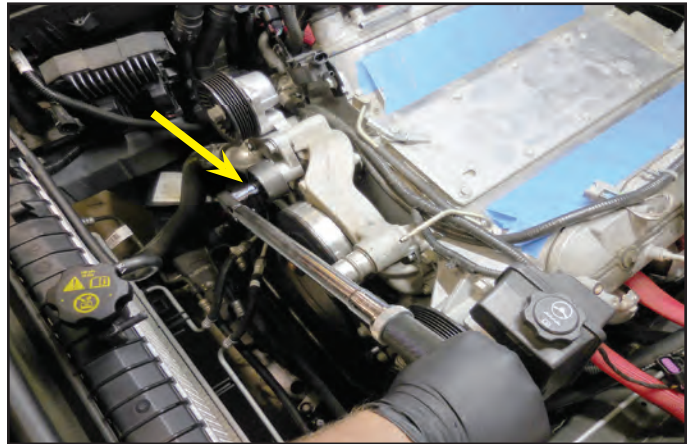

## Section 7: Valley Cover, Steam Pipe, & Coil Bracket Replacement

78. Use a 10 mm socket to remove the two bolts holding the OEM steam pipe to the heads.



79. Remove the OEM steam pipe, this will not be reused. Remove the old O-rings from the cylinder heads if they did not come off with the steam pipe.





80. Disconnect the electrical connector from the Valley plate OEM Oil Pressure Sensor by pulling up on the white locking tab and pressing tabs to release the connector from the sensor. **NOTE: L99 vehicles will have to also disconnect the DOD sensor electrical connector. This will not be reconnected as the DOD system will be disabled. We recommend covering the connector in electrical tape or heatshrink to keep moisture out. Retain connector to harness to avoid damage.**

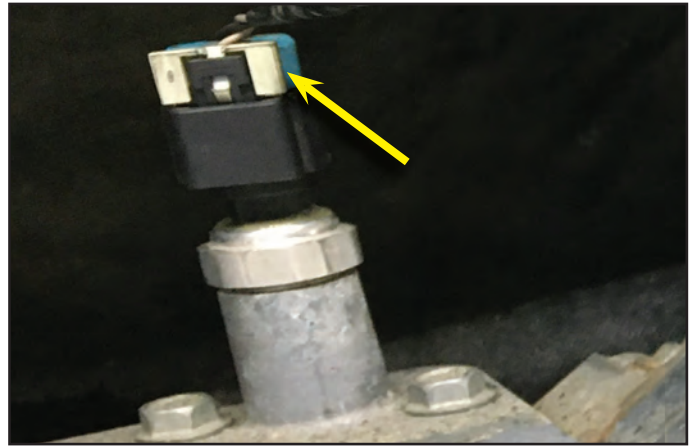

81. Using a 27mm (1-1/16") wrench, remove OEM Oil pressure sensor from the valley plate. Put the sensor safely aside to be re-used with the new sensor adaptor.



82. Use a 13mm socket to remove the 11 mounting bolts holding the OEM Valley Cover to the cylinder block. OEM Valley Cover and bolts will not be re-used.

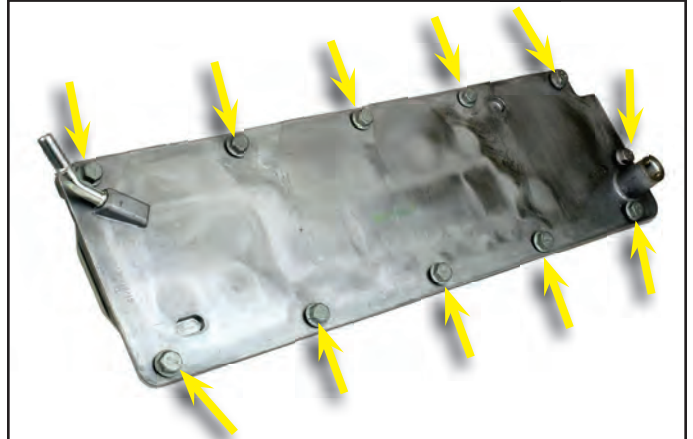

83. Gather the supplied Valley Cover, Oil Sender Adapter and 11x countersunk bolts. Gaskets are pre-installed into the new Valley Cover. Ensure all gaskets / O-rings are installed as shown. **NOTE: Bolts not shown in picture. The two longer countersunk bolts will be used to mount the Oil Sensor Adapter.**



84. Remove the OEM Valley Cover. Make sure to remove the OEM gasket. (Shown with arrow) Use a shop towel with denatured alcohol, or some other non-petroleum based solvent to clean the block sealing surfaces before installing the new Valley Cover and Oil Adapter.

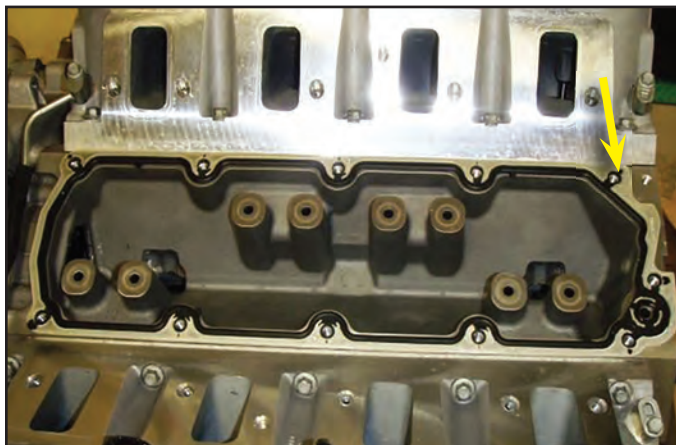

85. Here is the torque sequence for the new Valley Cover & Oil Adapter.



86. Install the Magnuson Valley Cover using the supplied hardware. The Oil Adapter will be installed on top of the Valley Cover and uses the two longer bolts (bolts 10 & 11). **Torque the bolts hand tight in the sequence shown in the previous step and then torque to 18 ft-lbs. also using the same sequence.**



87. Use a 27mm (1-1/16") wrench to install the OEM Oil sensor into the Magnuson Oil Sensor Adaptor.



88. Plug electrical connector back into the Oil Sensor and lock the white tab.



89. **NOTE: Make sure there is a new O-ring installed on the bottom side of each block of the provided steam pipe before installing!** Locate and mount the provided steam pipe to the vacated bosses on each head. **Secure in position with the OEM mounting bolts with a 10mm socket and torque to 108 in-lbs. Verify your torque wrench settings.**



90. Gather the OEM coil pack assemblies along with the new coil pack brackets. Each bracket assembly will require 8-spacers and 8-nuts as shown. There are also 5 new bolts per side to attach the bracket to the valve covers.

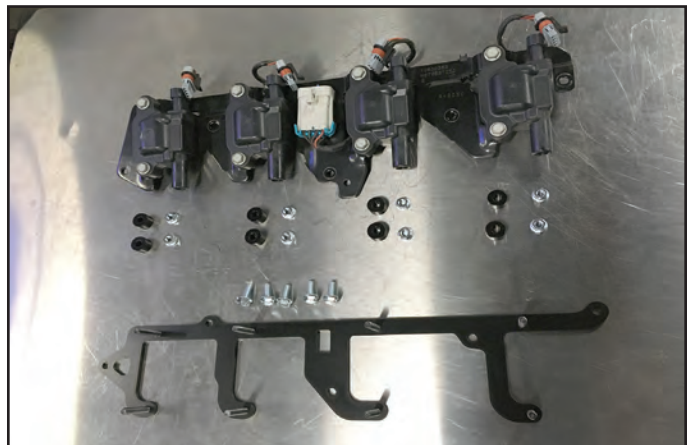

91. Start by disconnecting each harness wire from the coils on both OEM coil pack assemblies.



92. Use a 10 mm socket to remove the mounting bolts holding the coils to the OEM mounting brackets.



93. This is a separated coil pack set, mounting bolts, and remaining bracket.



94. Use a flathead screwdriver to release the tab holding the harness female plug terminal to the mounting brackets.



95. Pull the plug terminals away from the brackets.

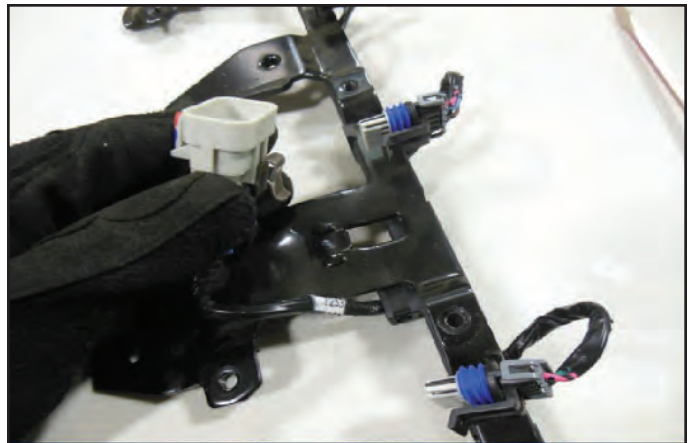

96. This shows the plastic cover over the wiring harness attached to the coil pack mounting brackets.



97. Use a small flathead screwdriver to release the tabs locking these covers over the harnesses on the mounting brackets.

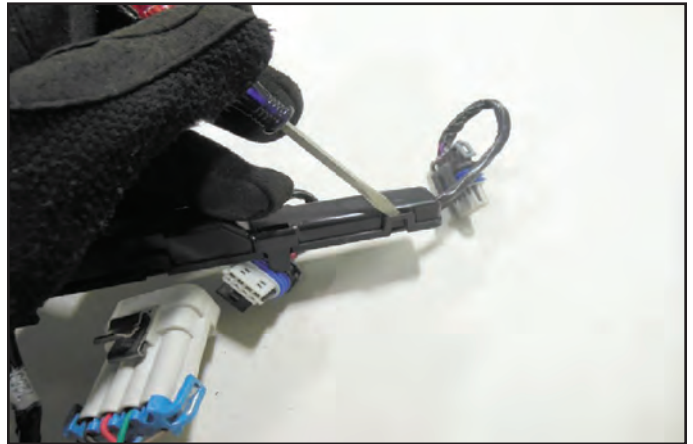

98. Remove the covers completely from the wiring harnesses, and separate harnesses from the mounting brackets.



99. Place a provided spacer on each of the studs on the new coil pack mounting brackets.



100. Install one Coil Pack with the connector end oriented to the flat "top" of the mounting bracket. Use a 10mm nut driver or wrench to secure the OEM coil to the new coil pack bracket.



101. Orient the OEM wiring harnesses as shown with the plugs at the top, lay the bracket down over the wiring harness and wrap the main female plug around to the front as shown. The studs should be pointing up as shown in this picture.



**NOTE: Do not attach the clip on the center connector until after installed onto the engine, as you will need to get to the hole under the connector during installation onto the valve cover.**

102. With the OEM wiring harness loosely in place, install the remaining coil packs and nuts. **Torque the nuts to 108 in-lb. Verify your torque wrench settings.**

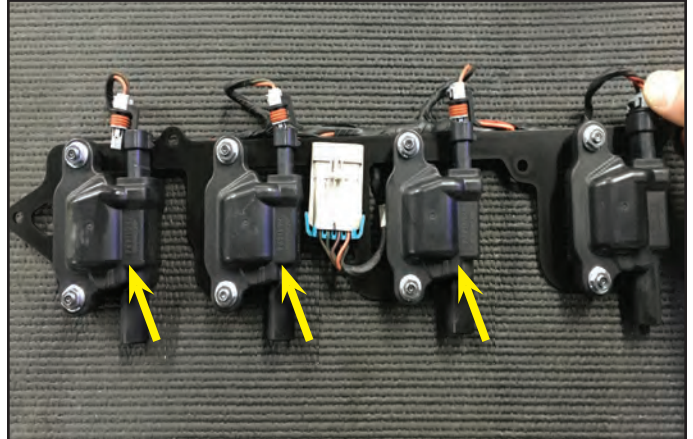

103. Connect the plugs to each of the coils on the mounting brackets.

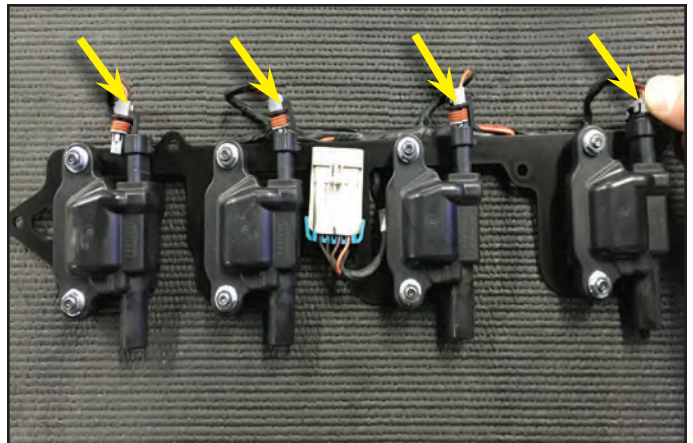

104. Flip the assembly over and zip tie the harness to the coil bracket in the 3 places shown.

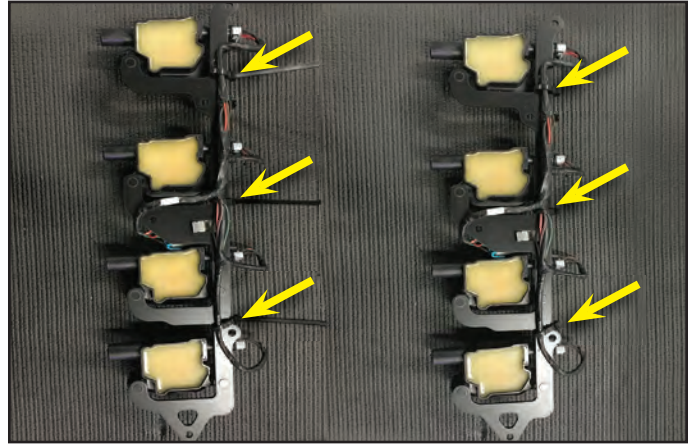

105. This shows the completed assembly to the right with the OEM parts that will not be reused shown on the Left. We suggest that you keep your OEM parts separate in case you want to return your vehicle to “stock” and mount the supercharger system on your next Camaro.



106. Remove the two heater hose clamps at the water pump. These clamps will be re-used.

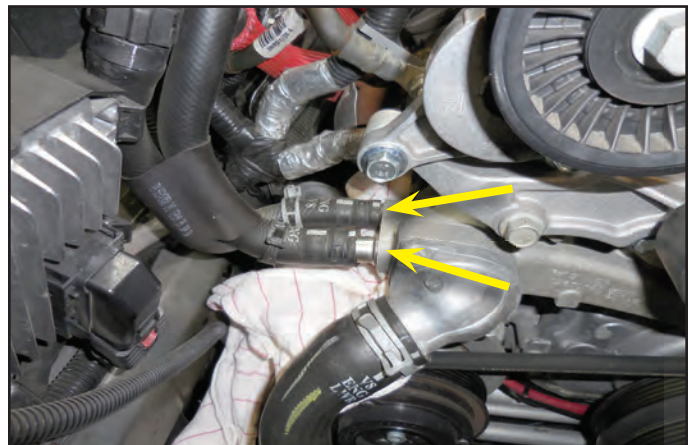

107. Remove the two heater hose clamps near the firewall. These clamps will be re-used. Remove the two heater hoses. The heater hoses will not be re-used and may need to be cut to be removed from the barbs.



108. Here are the four OEM heater hose clamps that will be re-used. There are two small, and two large clamps that you will need to save for use after the coil brackets are installed.



109. Place a bead of Blue Loctite 242 on the new coil pack mounting bolts shown here.



110. Install the new coil pack bracket assemblies on the valve covers. Install the bolt shown with arrow first on each side.

**NOTE: Driver side tight hole in coil bracket shown. The tight hole will be on the rear of the engine on the passenger side.**



111. Make sure not to miss the bolt under the connector. **Torque the mounting fasteners down to 108 in-lbs.** with a 10 mm socket.





112. Slide the metal mounting tab on the back of the plug into the slot on the new coil pack mounting brackets completely as shown. The “Teeth” of the metal tab will lock the plug in position. **NOTE: During the disassembly process the tab needed to be bent to remove the connector. This tab may need to be bent back to grip the bracket and hold the connector properly.**

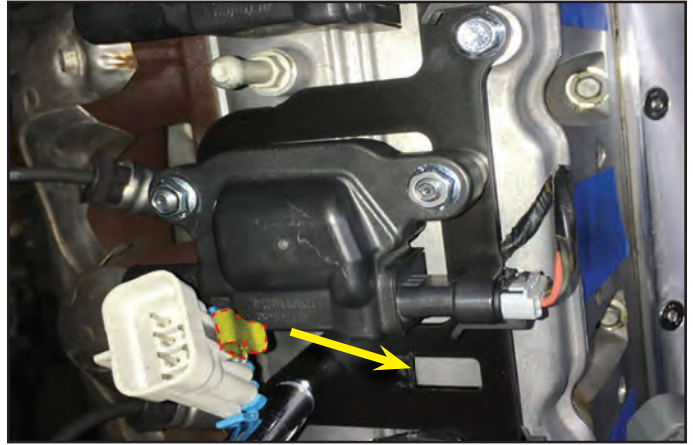

113. Connect the harness coil pack plug to the coil pack bracket connectors on both sides of the engine.

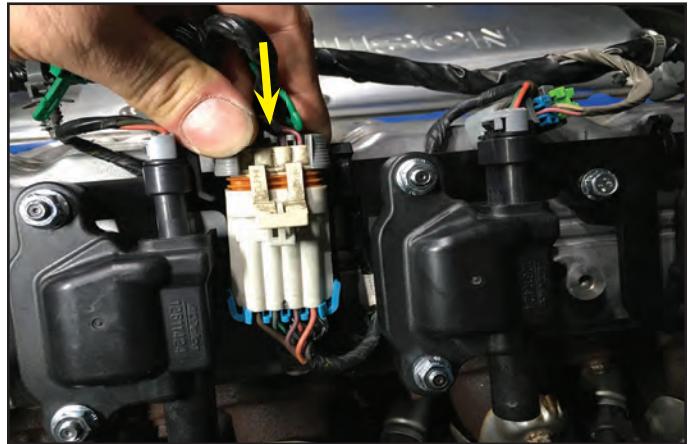

114. Engage the locking clips securing the coil pack connectors in position.



115. Reconnect the plugs to the coils on both sides of the engine. Ensure you get the wires and jackets completely in position.

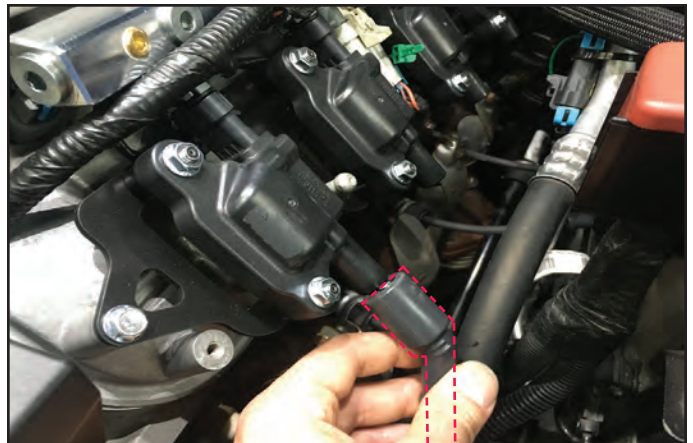

116. Install the provided heater hose with the smaller 5/8" hose end on the rear water pump fitting, and connect the opposite end of this same hose to the larger 3/4" inboard fitting at the firewall.

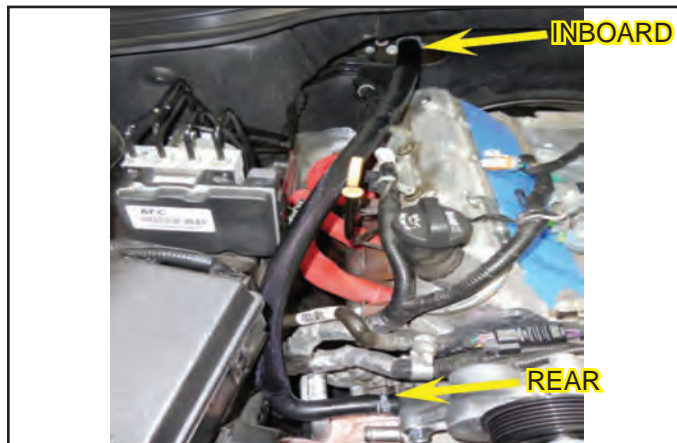

117. Install the other heater hose to the remaining fittings as shown. Use the OEM clamps just removed to secure these new heater hoses. The front port on water pump is 3/4" and the outboard fitting at the firewall is 5/8".

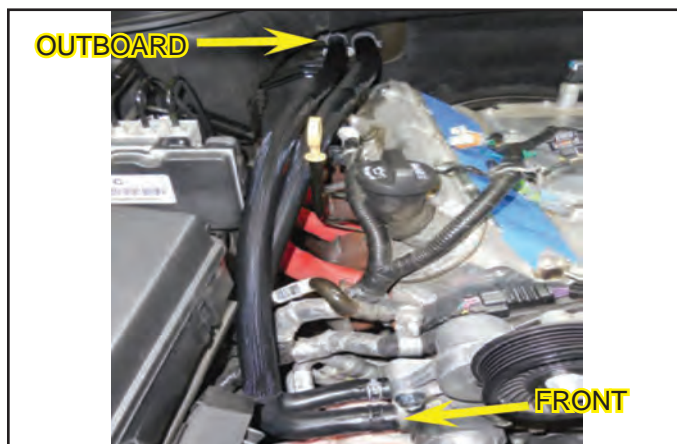

### Section 8: Wire Harness Extensions, and Intake Manifold Parts Removal

118. Use a small screwdriver to spring the release tab on the EVAP Solenoid mounting bracket. Remove the EVAP Solenoid from the vehicle and set aside for reinstallation later.



119. Use a 15 mm wrench to remove the EVAP Solenoid mounting bracket from the right hand side, front of the head. The bracket and fastener will not be reused.



120. Gather the provided throttle position control extension harness.

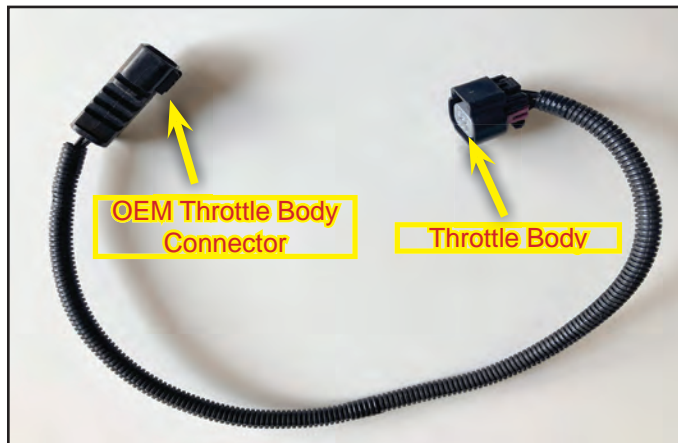

121. Connect the larger female connector to the OEM throttle control connector on the right hand side of the engine just behind the tensioner pulley as shown.



122. Route the harness behind the water pump, under the steam vent pipe and over to the left hand side of the engine. Secure to the existing harnesses using the provided zip ties. The remaining smaller male connector goes to the throttle body in later steps.

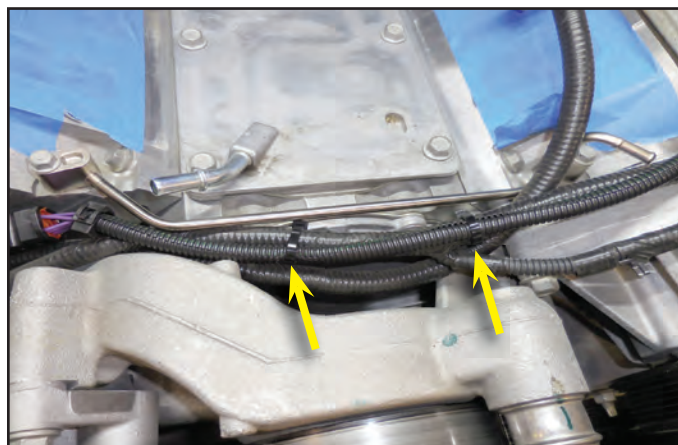

123. Gather the EVAP breakout harness shown here. (Some connections will be made later in the install)

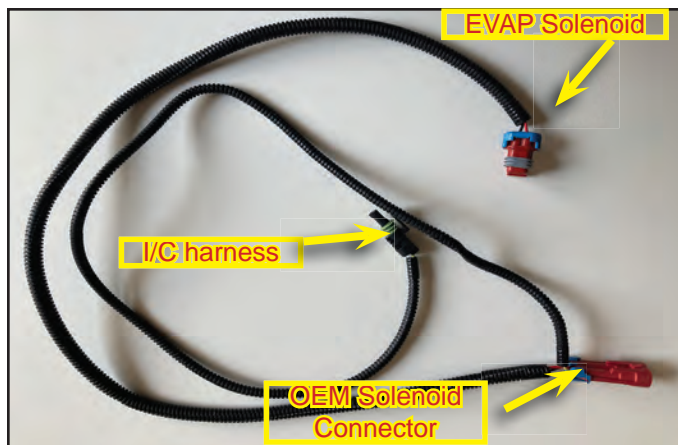

124. Connect the EVAP harness female connector to the male plug the was previously connected to the EVAP solenoid. This harness is located on the right hand side of the engine adjacent to the oil fill spout. Route the single yellow wire connection off toward the fuse box. It will be used in a later step to connect to the intercooler pump harness.

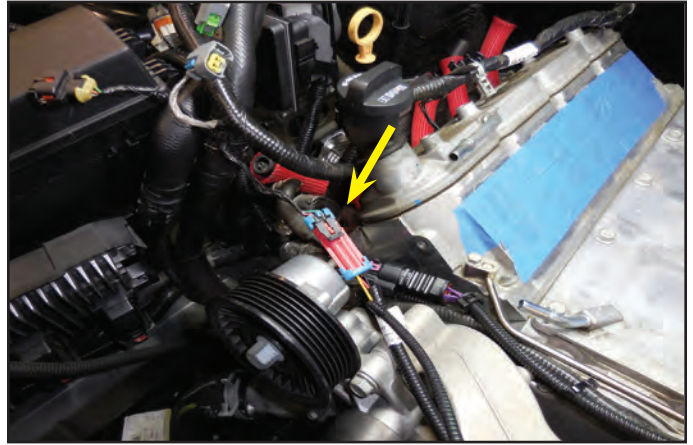

**NOTE: Supercharger shown in place for reference this will not be installed until later steps.**

125. Route this EVAP breakout harness wire back to the fire wall, over to the left hand side of the engine. Secure to the existing harnesses using the provided Zip-ties. Secure hose/harness to a heater hose at one point to prevent the hose from sagging.

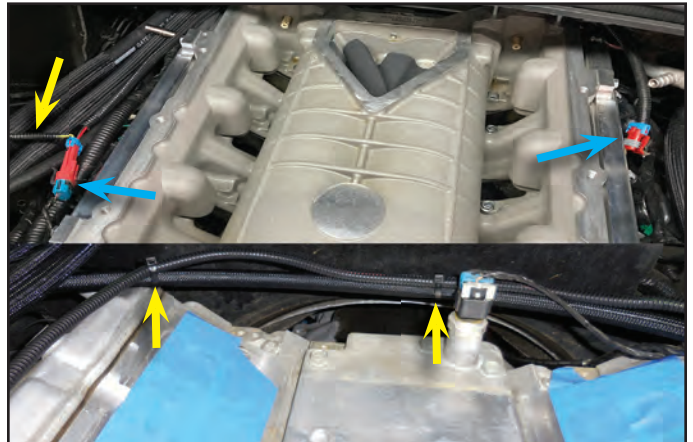

126. Use a pry tool hook to remove the injector harness mounting tie "trees". These will not be reused. You can also cut them off, just be careful to not damage the harness.



127. Use a pair of diagonal pliers to cut the existing stand-off mounting tabs from the coil pack harness as shown.

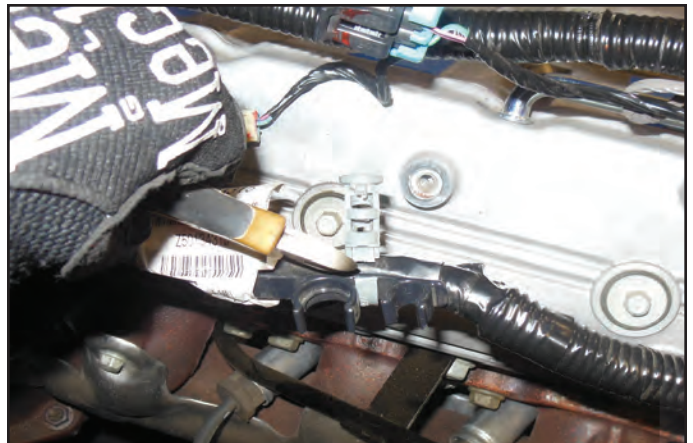

128. Use a 10 mm socket or nut driver to remove the four throttle body mounting bolts from the OEM intake manifold. Remove the throttle body and set aside for later installation.



129. Remove the clamp securing the brake booster. Remove the fitting and the hose clamp and set aside for later use.

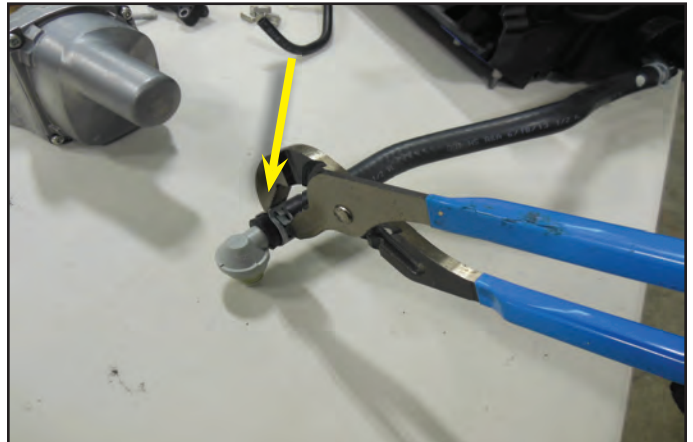

130. Connect the OEM brake booster valve to the end of the supplied 23" long 15/32" ID hose that is closest to the mesh sleeve, securing in place with the OEM spring clamp.

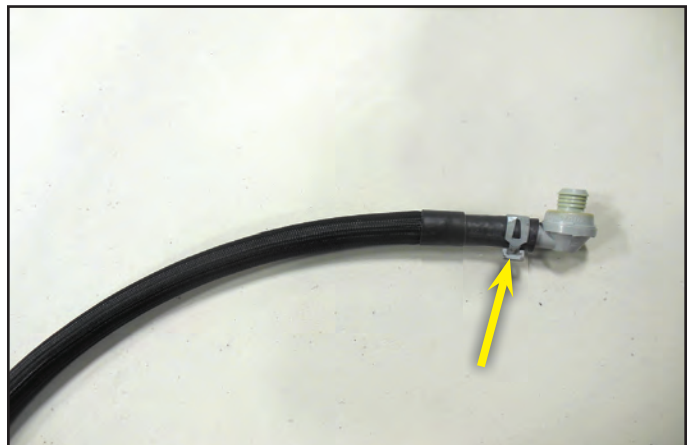

131. If equipped, pull the vacuum hose from the back of the OEM intake manifold next to the vacuum hose that went to the brake booster.



132. This is the line removed from the OEM intake manifold. Save it for later use.



133. Gather the metal fuel connector, clamp and the 36" long 3/8"ID sleeved fuel safe hose. Assemble the connector into the hose using the clamp as shown.



134. Gather the plastic straight quick connector and clamp. Assemble the connector into the opposite end of the 36" long 3/8"ID hose using the clamp as shown.



135. Here is the completed EVAP hose assembly.



136. Press the EVAP hose extension onto the EVAP hard line on the right hand side of the engine, behind the heat shield adjacent to the fuel line. Route EVAP hose around the back of the engine and temporarily place the end near the brake booster to keep it from getting in the way during the supercharger install. Attach the hose to the harness with zip ties as was done with the EVAP harness for support in a previous step.

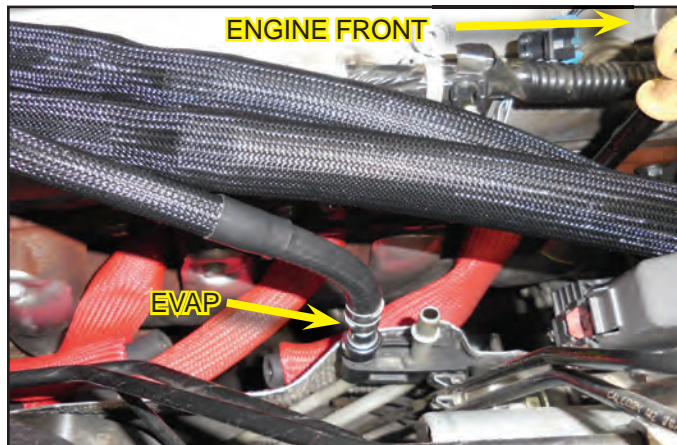

**NOTE: We recommend keeping zip ties loose.**

### Section 9: Supercharger Preparation and Install

137. Gather the provided 52" long 3/8" ID hose and install two clamps to it as shown in this photo.



**NOTE: One end of this hose will be a short formed 90 degree bend. This end will attach to the rear port on the LH (driver side) valve cover.**

138. Attach the short 90 degree end of the 52" long 3/8" ID hose from the last step at the arrow location at the LH valve cover. Route as approximated by the green highlighted line around the passenger side valve cover and behind the engine along the EVAP harness and over the passenger side coils to keep it safe during the supercharger housing install.

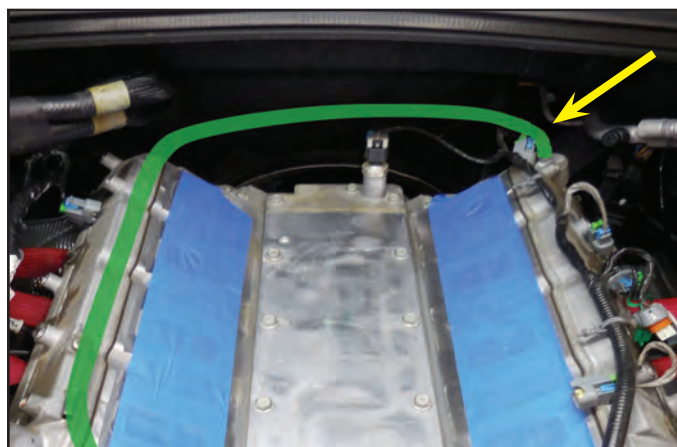

**NOTE: One end of this hose will be a short formed 90 degree bend. This end will attach to the rear port on the LH (driver side) valve cover.**

139. Carefully unwrap your supercharger assembly. It's a good idea to place a cap or tape over the supercharger inlet to protect from debris.



140. Remove the 15 bolts holding the supercharger lid (cover) to the housing and pull the lid (holding the intercooler assembly) off the housing. Place the lid aside for re-install shortly. Ensure that the lid is in a clean location and preferably covered to prevent any contamination by debris.

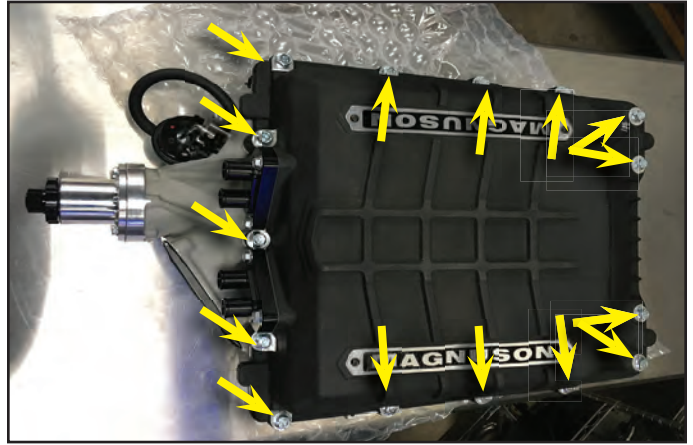

141. With the lid now removed, we suggest checking to make sure all the intake port PIP gaskets are still in place and haven't been disturbed or damaged. **There are 8 port gaskets in total to check.**

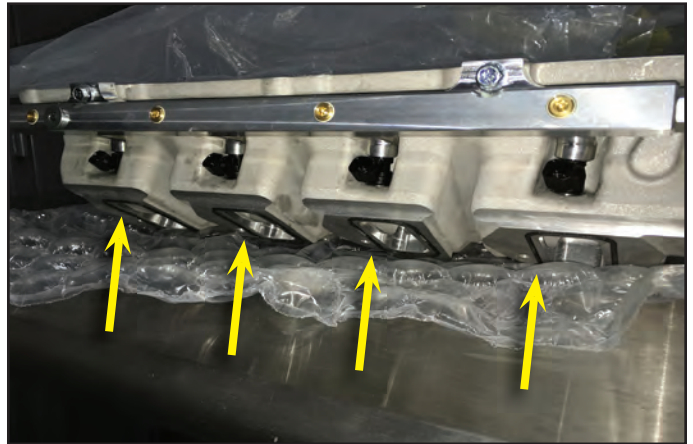

142. Gather the supplied throttle body adapter and 4 M6 x 25mm bolts.

**NOTE: Port locations may be slightly different from the image.**



143. Make sure the gasket is in place before installing the throttle body adapter to the supercharger housing. **Torque bolts to 108 in-lbs.**





144. Verify that your supercharger mating surface is clean. Apply blue Loctite to and install 4 M8 x 30mm bolts into the 4 rear bosses on the supercharger housing as shown. Make sure to only thread in the bolts partially to allow the lid to slide under the bolt heads when installed in later steps.



145. Locate the supplied 30" long 1/4" ID coolant overflow hose and clamp. Install the hose onto the steam manifold outlet as shown. Route hose off to the right to keep it out of the way for the next steps.



146. Remove the tape or shop towels covering the intake ports on your heads, and clean using alcohol or some other non-petroleum based solvent using a clean shop towel.

**NOTE: Be careful to avoid letting any debris fall into the exposed intake ports.**



147. Before placing the supercharger housing onto the engine, it may be helpful to put a small block of wood, or a roll of bubble wrap to hold the supercharger housing up temporarily to allow the injector connections to be made. Otherwise you will have to lift each side and make the connections. After the 8 injector connections are made, completely remove object used to lift the housing.

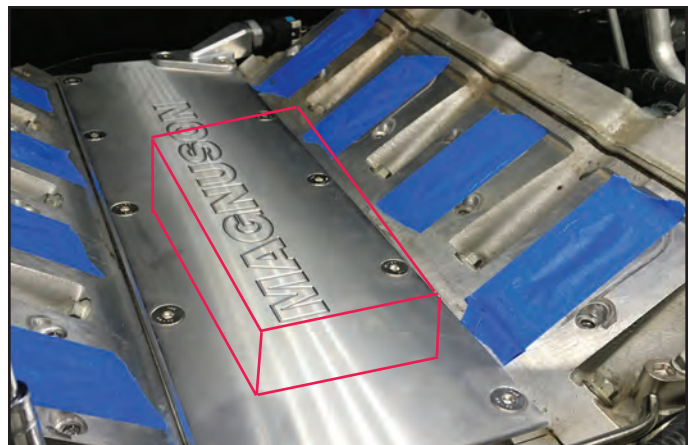

148. It's helpful to spray the heads, or gaskets with a mist of silicone spray, or mild soapy water to aid in this step. With the help of an assistant, carefully guide the supercharger housing assembly onto the engine.

**NOTE: Be careful to avoid letting any water or debris fall into the exposed intake ports.**



149. Connect the injector plugs to the 8 injectors ensuring that they snap into place. Engage the locking clips and tuck the wiring harness below the mounted fuel rail.

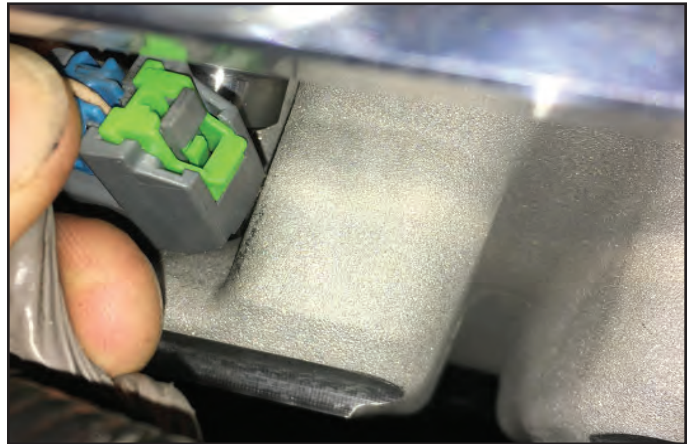

150. Remove any assembly aids and align the ports and bolt holes. Carefully slide the assembly around to achieve alignment. There should not be any "rocking" or "tipping" when the supercharger is completely contacting both heads evenly.

**NOTE: Be careful to avoid letting any debris fall into the exposed intake ports.**



151. Place a small bead of supplied blue Loctite 242 on the ten supplied M6 x 40mm supercharger mounting bolts.



152. Very carefully insert the provided 10 M6 x 40mm supercharger mounting bolts through the holes in the outer ring of the supercharger. It's a good idea to use a magnet tool to avoid the bolts dropping into the exposed ports.

**NOTE: DO NOT immediately torque each bolt to full specs, do the torquing in steps!**

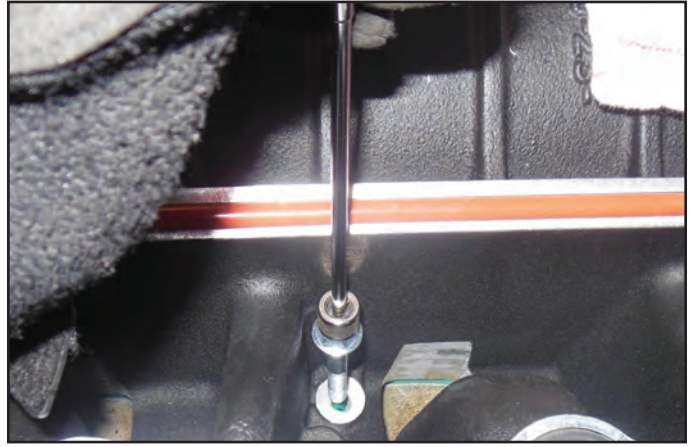

153. Before torquing, first snug (hand tighten) all fasteners using the tightening pattern shown in the next step. **Torque the mounting bolts down following the pattern shown to 108 in-lbs.** This picture shows you the torque sequence.

**There is a larger version of this diagram at the back of this installation manual.**

**NOTE: Rotate the pulley on the supercharger to ensure that it turns freely after you finish torquing these bolts.**

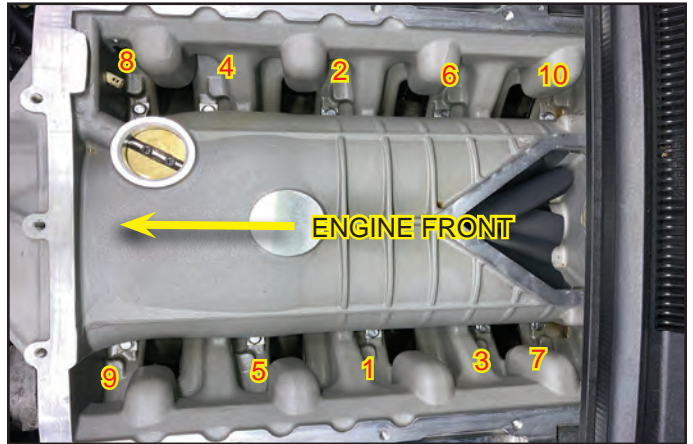

154. Gather the provided 30" long 1/4" ID hose. Connect to the right hand PCV port on the right hand side, front of the valve cover. Secure in position with one of the provided dark-gray spring clamps in the area shown with a yellow arrow. Place hose off to the right hand side until needed in later steps.



155. The 30" long PCV hose (highlighted green) from the last step will be routed toward the fuse box temporarily. The opposite end will be attached to the Air Inlet Tube later in the installation. Route the 52" long PCV hose (highlighted red), that was installed earlier, as shown behind the bypass actuator.



156. Route the 52" long PCV hose (red arrows) from the last step to the lower port on the supercharger behind the bypass actuator.

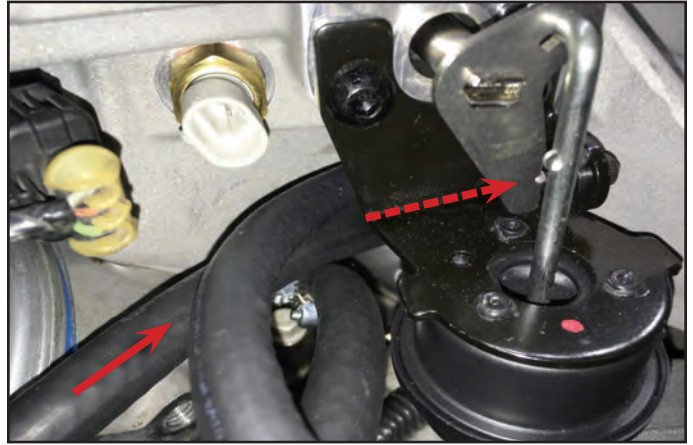

157. Secure the 52" long PCV hose from the last step with a worm gear clamp as shown at the arrow. **Note: Make sure to orient the clamp as shown for tool access.**

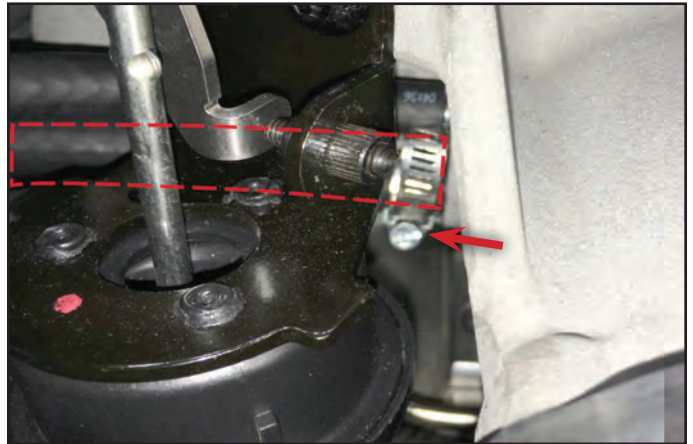

158. Connect the MAP sensor connector to the MAP sensor on the right hand side of the supercharger assembly just behind the bypass valve.

**NOTE: Make sure the wires aren't pinched between the oil fill and the fuel rail.**

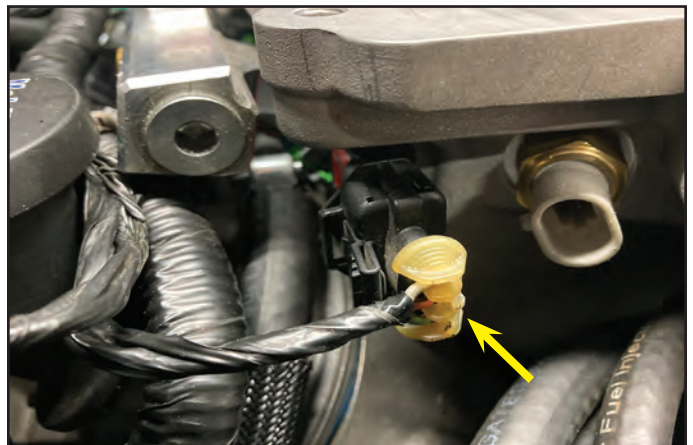

159. Ensure that the gasket on lid of the supercharger assembly is properly seated, place a small film of provided Lubriplate lubricant on the gasket and while you're doing this, feel for inconsistencies! Your fingers are more sensitive than your eyes.



160. Remove any tape covering the supercharger discharge or bypass outlets. Now will be your last opportunity to use a shop vacuum to go over the ports to ensure no debris has fallen into the open ports.

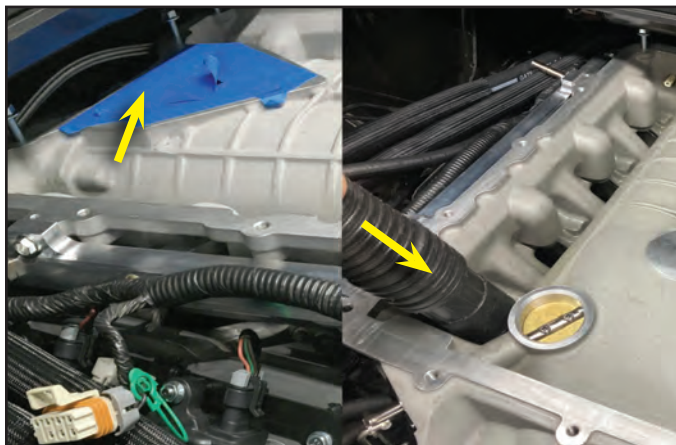

**NOTE: Remember to remove any tape from the supercharger before installing the lid.**

161. Relocate the lid on top of the supercharger assembly by carefully sliding the lid under the heads of the 4 rear bolts that were pre-installed into the housing.

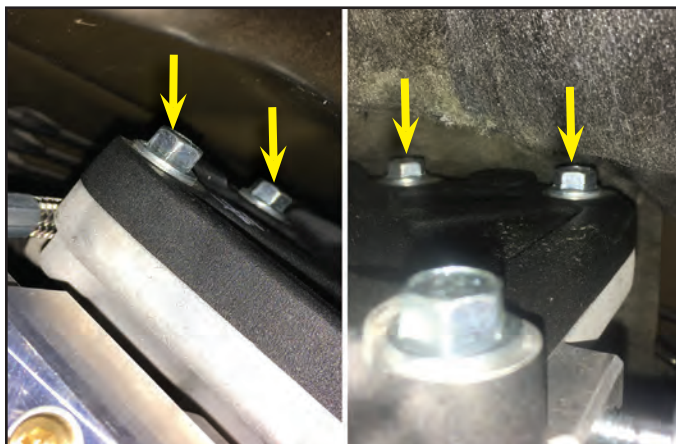

162. Place a small bead of blue Loctite 242 on each of the mounting fasteners for the supercharger lid mounting, note the two sizes and locate. 9 - M8 x 30mm and 2 - M8 x 50mm shown with arrows.

**NOTE: DO NOT immediately torque each bolt to full specs, do the torquing in steps!**



163. Start each of the fasteners by hand and finger tighten in the sequence shown. **Then torque the fasteners down to 18 ft-lbs.** in steps using the sequence shown in the image.

**There is a larger version of this diagram at the back of this installation manual.**

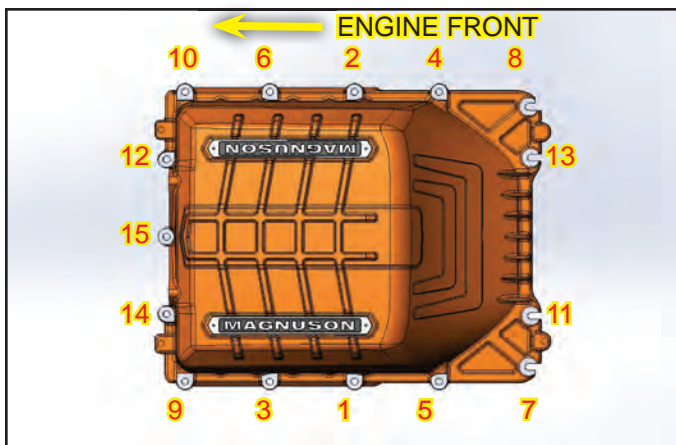

164. Connect the EVAP tube you routed behind the engine earlier to the OEM EVAP solenoid rear barb. Connect the EVAP breakout harness wire electrical connection you also routed behind the supercharger to the EVAP solenoid.

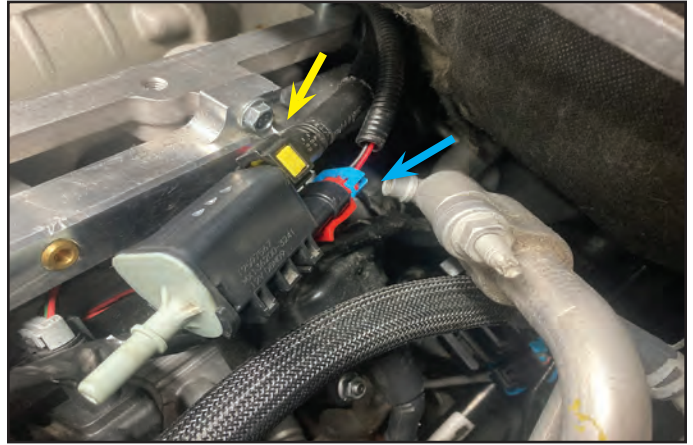

165. Retain the EVAP solenoid to on the back left hand side of the fuel rail as shown.



166. This stud on the coil pack mounting bracket is being used to anchor the wire harness shown in the next step. We will re-use the OEM fastener in this location on the right side of the engine.

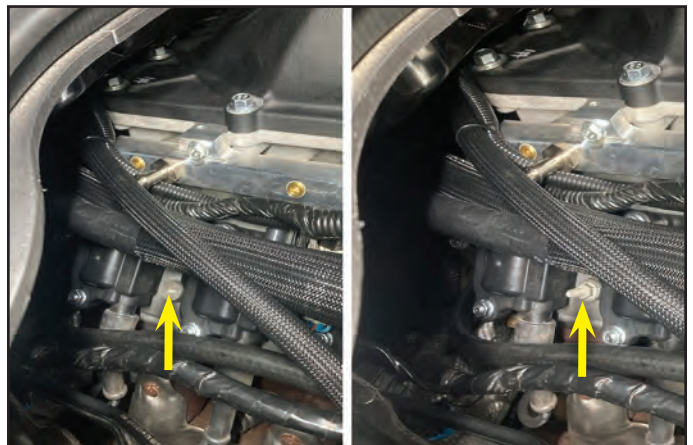

167. This is the stud mounting clip with the OEM tie removed.



168. Slide a provided zip tie through the top hole of the stud mounting clip as shown.



169. Align the assembled mounting clip/zip tie on the wire harness, with the mounting stud and pull the zip tie tight anchoring it to the wire harness. Press the mounting clip onto the stud securing the harness in position.



170. Install the provided acorn nut on left rear coil to protect hoses from getting cut.



## Section 10: Belt, Radiator, and Throttle Body Adapter Installation

171. Use a 15 mm wrench to rotate the tensioner (yellow arrow) and install the accessory drive belt as shown.

**Use the belt diagram given at the back of this installation manual.**



172. Verify that the radiator drain petcock on the left hand side, bottom of the radiator is closed and everything is clear behind the radiator.



173. Slide the fan shroud back down behind the radiator carefully, ensure that the clips at the bottom of the shroud have engaged with the mount locations on the radiator.

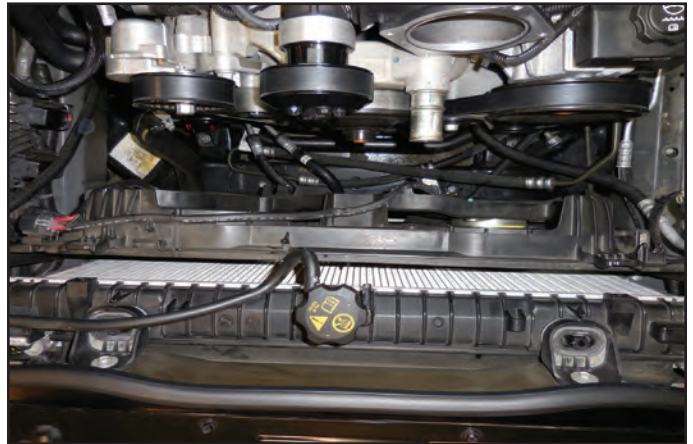

174. Secure the fan shroud to the radiator mount using the OEM mounting hardware.



175. Re-connect the wiring harness to the radiator shroud mounted connector.





176. Re-connect the OEM radiator hose to the water pump hose barb using the OEM spring clamp. Reconnect the free end of the hose back to the upper radiator hose barb on the left hand side of the radiator using the OEM spring clamp. Also connect the oil cooler hose if equipped.

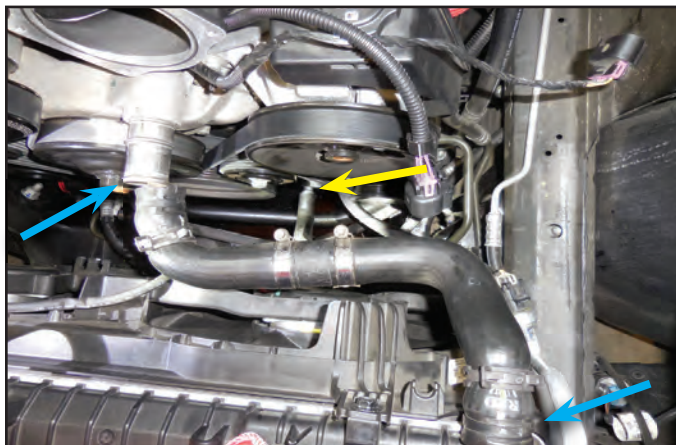

177. Re-connect the wiring harness mounting clips to the just re-connected radiator hose.



178. Connect the free end of the previously installed 30" long 1/4" ID coolant overflow hose that goes from the cross-over steam vent connector on the right hand side of the heads, below the supercharger housing inlet. Use the provided black spring clamp to make this connection shown with a yellow arrow.



## Section 11: Hose Line, Electrical Connections and Throttle Body Install

179. If equipped with an exhaust actuator you will have the OEM hose shown here that you removed in Section 8. Remove and discard the section to the right of the connector shown with the arrow. It will be replaced with the provided 1/4" diameter 21" length hose. If your vehicle does not have this feature you can skip ahead six steps.

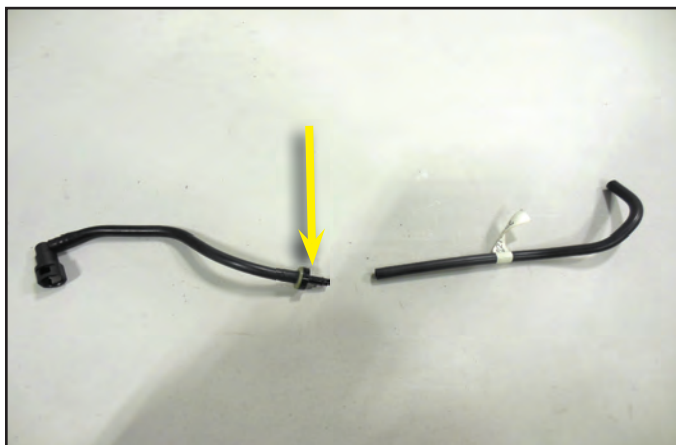

180. Gather and route the provided 1/4" diameter 21" length hose back below the injector connectors on the left hand side of the engine, between the valve cover and supercharger housing casting.

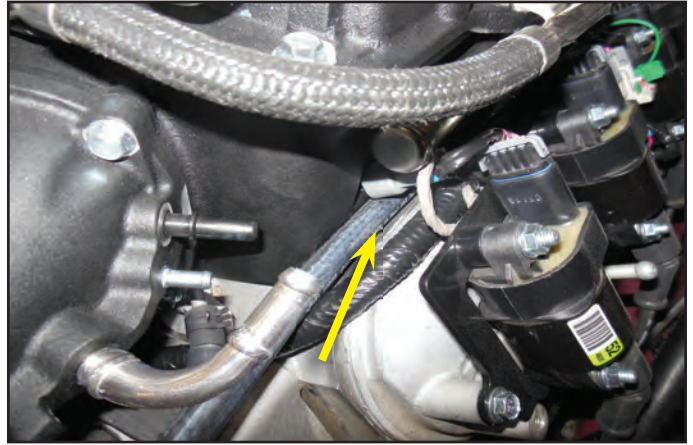

181. Pull the 1/4" diameter 21" length hose out behind the EVAP solenoid and out toward the left hand side fender to gain access as shown.

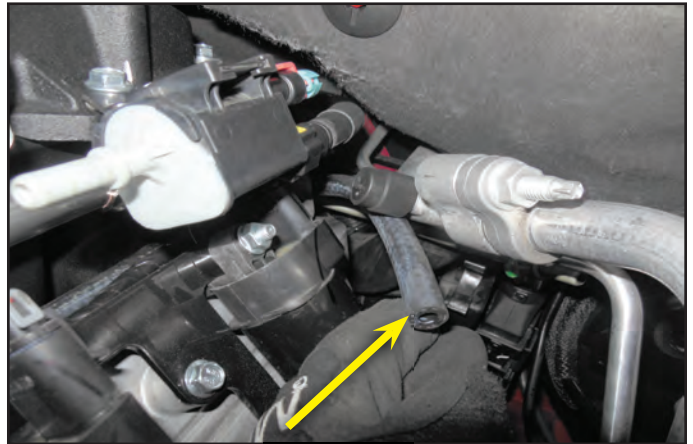

182. Connect the OEM hose shown at the beginning of this section to the hose installed in the last step.



183. Connect this connector to the hard line with the green locking tab by the firewall adjacent to the brake booster on the left hand side of the engine.



184. Pull the 1/4" diameter 21" length hose toward the front of the supercharger taking up the slack, and connect the free end to the 1/4" vacuum hose barb at the center of the supercharger inlet where shown with the arrow.

**NOTE: Port locations may be slightly different from the image.**

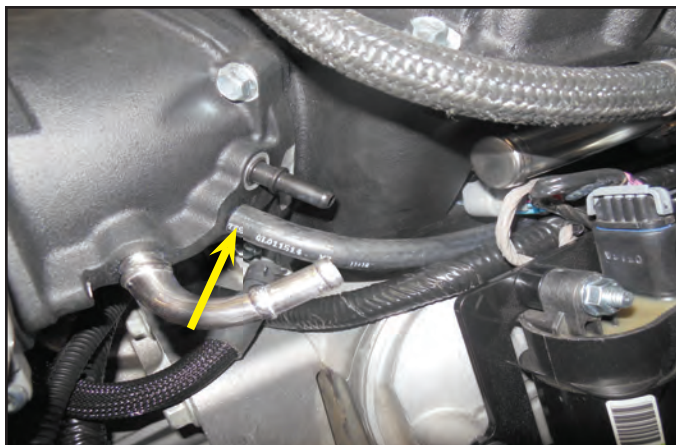

185. Gather the brake booster hose that was built in an earlier step for reinstallation.



186. Plug the brake booster valve back into the brake booster grommet. Route the free end of the hose under the A/C hard lines, above the coil packs and forward on the left hand side of the engine. Connect the free end of the hose to the remaining hose barb on the left hand side of the supercharger inlet.

**NOTE: Port locations may be slightly different from the image.**



187. Connect the vacuum hose between the EVAP solenoid and the hose barb at the top of the supercharger inlet on the left hand side of the engine. Make sure the connections have "clicked" and are locked in place.

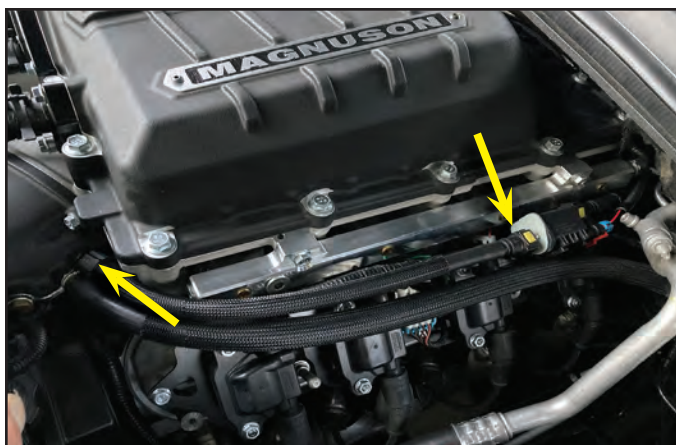

188. Use the provided hose clip to anchor the EVAP solenoid hose to the brake booster hose at the arrow location.



189. Lightly lubricate the outer leading edge of the male fuel connector with the provided Lubriplate grease. Connect the right angle connector of the provided fuel line to the back of the right hand side fuel rail connector. Pull on this connection, you should NOT be able to disconnect this hose without using a fuel line removal tool.



**NOTE:** You should feel/hear the locking ring engage, this should not be able to be removed without using the fuel line removal tool. Check your connection.

190. Lightly lubricate the outer leading edge of the male fuel connector with the provided Lubriplate grease. Connect the remaining end of the provided fuel line connector to the fuel line connection behind the heat shield on the right hand side of the engine compartment, just forward of the EVAP hose connected earlier. Again, pull on the connection, it should not be able to be removed without a fuel line removal tool. When verified, reinstall the OEM fuel line locking clip.

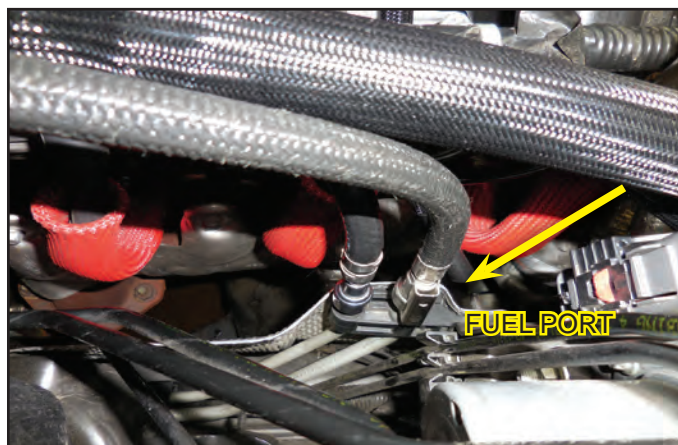

**NOTE:** Do not forget to Re-install the OEM fuel line locking clip.

191. Gather the provided MAF breakout harness shown here.

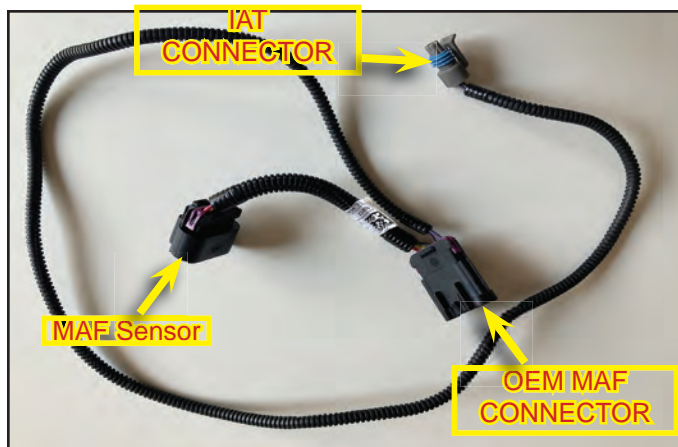

192. Make the connection to the OEM MAF connector. Engage locking tab.

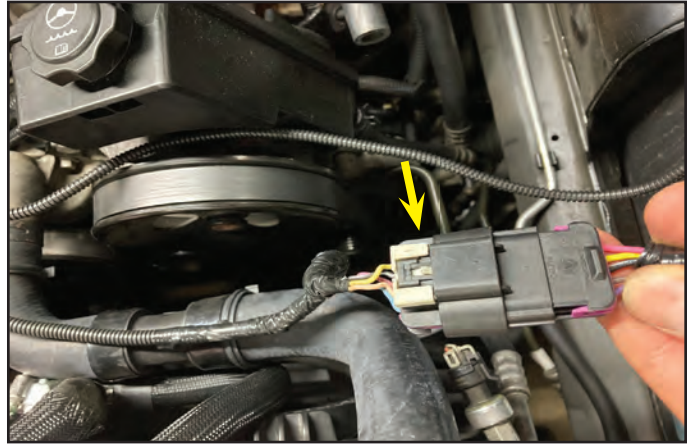

193. Route the provided IAT sensor connector/harness below the inlet.



194. Connect the harness to the IAT sensor. Anchor the harness to the existing hoses/harness at the water pump inlet hose barb. Continue to anchor to the harness along the radiator hose leaving enough slack to make the connection to the MAF sensor on the air box in a later step.

**NOTE: DO NOT over tighten the zip ties.**

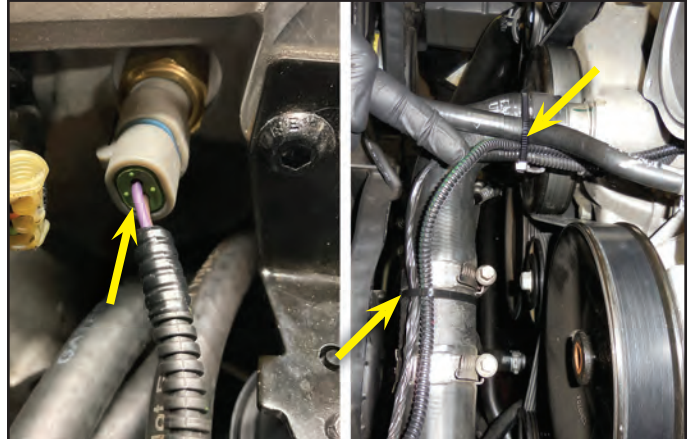

195. Make sure the throttle body O-ring is installed and fully seated. If you installed a cap or tape on the inlet remove it now.



196. Install the OEM throttle body to the supercharger inlet re-using the OEM bolts, **torque to 108 in-lbs.**



197. Attach the throttle extension harness plug to the throttle connector.



198. If your vehicle is equipped with an OEM oil separator modifications will be needed to re-install.



## Section 12: Front Fascia Removal, and Intercooler Pump Installation

199. Pry up on the locking tab of the six push pin rivets on the top of the fascia grill using a flat head screwdriver or pry tool.



200. When the locking tab of the push pin rivet is up, the bottom spreader can be pried up using a flat blade screwdriver or pry tool.



201. This shows the six upper push pin rivet locations. There may be shims installed between the bumper fascia and frame under these six points. Be careful later when removing the bumper.

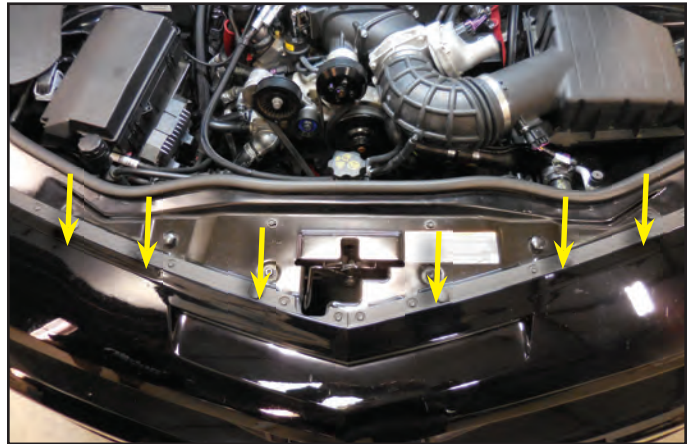

202. Use a 10 mm wrench to remove the two bolts connecting the fascia/grille to the sub frame at the bottom of the vehicle.



203. Disconnect the three bolts holding the plastic wheel well to the underside of the fascia with a 7 mm socket.



204. Several steps will be more accessible with the front wheels removed. Follow the instructions in your owner's manual for vehicle lifting, and wheel removal.



205. Use a T20 Torx screwdriver to remove the fasteners holding the wheel well to the perimeter of the fascia/grille, and fender.



206. The wheel well liners need to be removed completely to facilitate fascia/grill removal. Pry out the push pin rivets that secure the wheel wells to the sub-frame. Remove the T20 Torx fasteners at the perimeter and remove the plastic wheel wells from the vehicle. Set aside for later re-install.



207. Wheel well liner shown being removed.





208. Remove the now exposed fascia/grille mounting bolts holding the assembly to the vehicle. There are three that need to be removed with a 10mm socket and one with a 7mm socket.

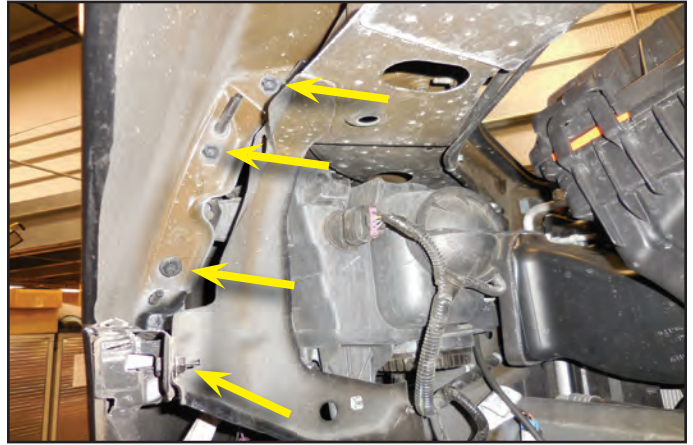

209. Disconnect the harness connection for the lights at the right hand side forward at the grille.



210. Remove the two (one each side) remaining bolts holding the fascia/grille to the vehicle at the top corners, verify everything is disconnected and carefully remove the fascia/grille from the vehicle. The fascia/grille should simply pull away.



211. Remove the six bolts holding the bumper impact bar in place.



212. Front bumper shown removed. Remove the plastic rivets holding the three air ducts in place, and remove all three ducts. Also disconnect the outside air temperature sensor shown with the blue arrow.

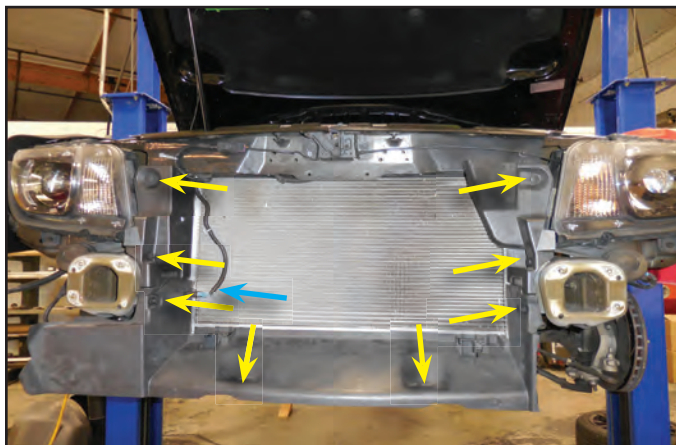

213. Gather the intercooler harness shown here.

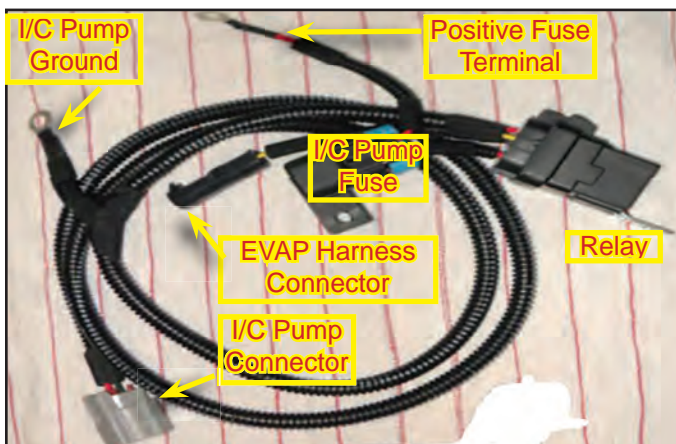

214. At the bottom of the right hand side, forward corner of the fuse center, mount the provided intercooler relay and fuse mounting bracket with the provided nut using a 10 mm wrench. This view is from inside the right hand side fender looking up at the bottom of the fuse center.



215. Mount the intercooler harness relay to the rear stud of the mounting bracket with a provided nut and secure with a 10 mm wrench; route the trigger wire (yellow) covered in wire loom, down and back behind the fuse center.



216. Install the provided 15A fuse in the fuse center, and mount the fuse center tab to the stud remaining on the mounting bracket using the provided nut and secure with a 10 mm wrench.



217. Remove the cover of the fuse center. Remove the nut of the positive terminal at the forward, fender side of the fuse center with a 13 mm socket and install the eyelet terminal of the red wire from the fuse box of the intercooler pump relay.

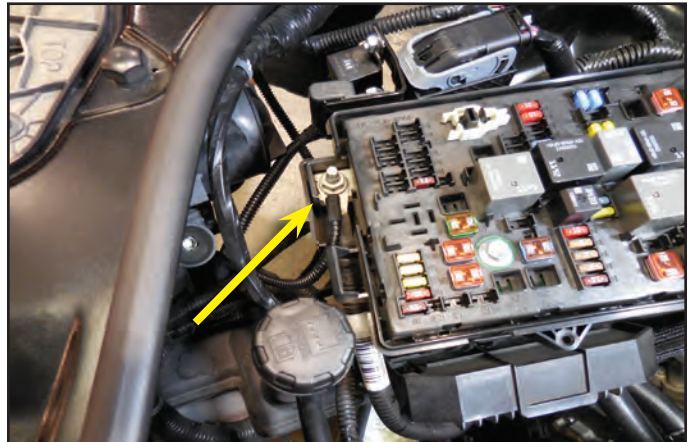

218. Earlier you routed an EVAP breakout harness wire over to the right hand side of the engine. This is the "trigger" wire for the intercooler pump. Route this wire down along the main wire harness "Y", behind, and up toward the fuse center. Secure this harness to the existing harness with the provided zip-ties as shown.



219. Connect the yellow wire from the relay of the intercooler pump harness to the "trigger" wire you routed up from the EVAP breakout harness earlier just behind the fuse center. Secure using a provided zip tie to the adjacent factory harness.



220. Remove the right hand side horn mounting bolt using a 10 mm wrench (the horn will stay in place with existing clips) and replace incorporating the provided intercooler pump bracket to the right hand side lower horn mounting bolt, add the provided M6x16mm bolt and nut at the hole in the forward flange of the mounting frame as shown. **Torque the OEM mounting fastener and the provided nut/bolt to 108 in-lbs.**

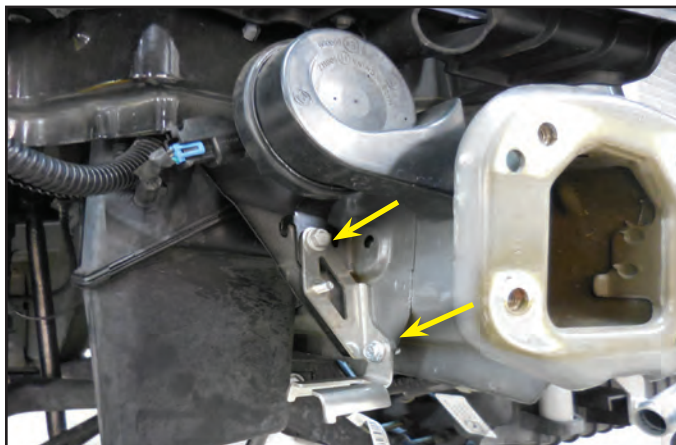

221. Route the remaining harness down and forward of the radiator overflow and connect the ground wire of the harness to the remaining stud on the intercooler pump mounting bracket just below the horn at the right hand side, forward of the wheel well. Secure in place with a provided nut and 10 mm wrench. **Torque to 108 in-lbs. Verify your torque wrench settings.**

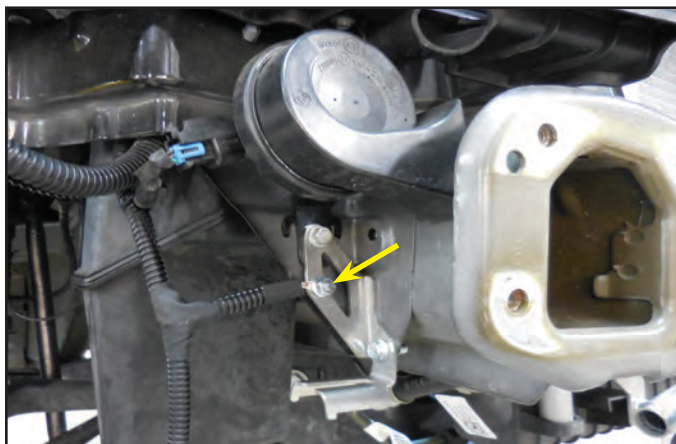

222. The pump should come with the rubber mount pre-installed in the orientation shown. The "W" shaped slot is highlighted in green.



223. Slide the provided intercooler pump onto the pump mounting bracket installed earlier with the hose barb pointing forward, and out toward the right hand side fender as shown. The metal tabs of the bracket should sit flush with the back side of the rubber isolator. Connect the intercooler pump harness terminal to the pump, ensure it snaps into position. It may take some force to get the connector to click into place.



224. Secure the provided intercooler reservoir mounting bracket to the right hand side upper fan shroud mount using the provided 16mm long bolt. Secure with 10 mm wrench.

**Do not reuse the factory mounting fastener.**



225. Mount the provided intercooler reservoir bottle to the just secured mounting bracket using the provided fasteners and secure with 10mm wrench. Do not completely tighten bolts. The bottle will need to be held up during the fill process.

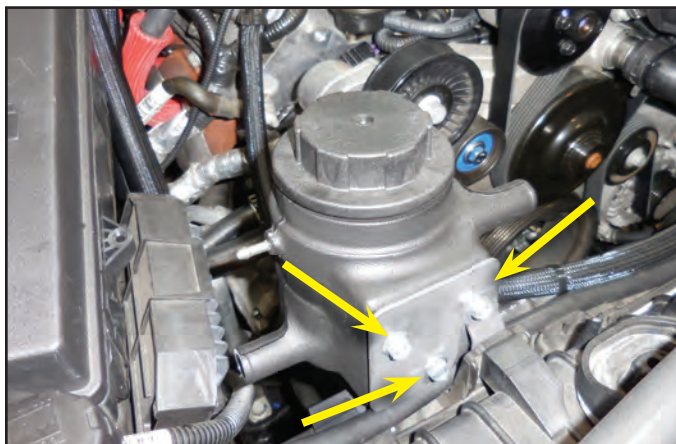

### Section 13: Low Temperature Radiator (LTR) Installation

226. Apply the provided sticky-back foam strips to the back-side of the Low Temperature Radiator (LTR) by pulling off the paper shields and pressing in place.

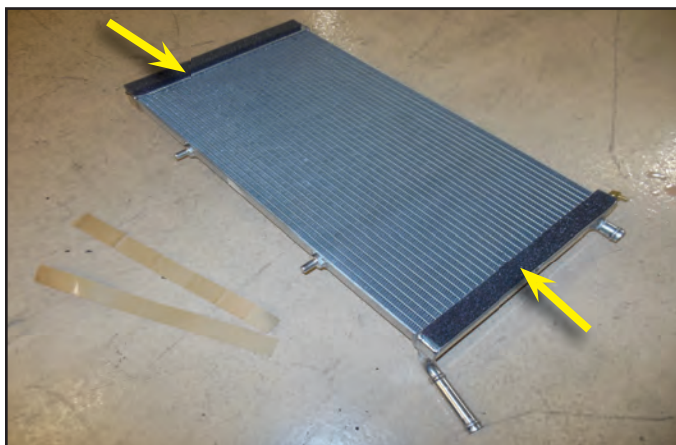

227. Gather the provided Upper LTR to Supercharger intercooler hose assembly.

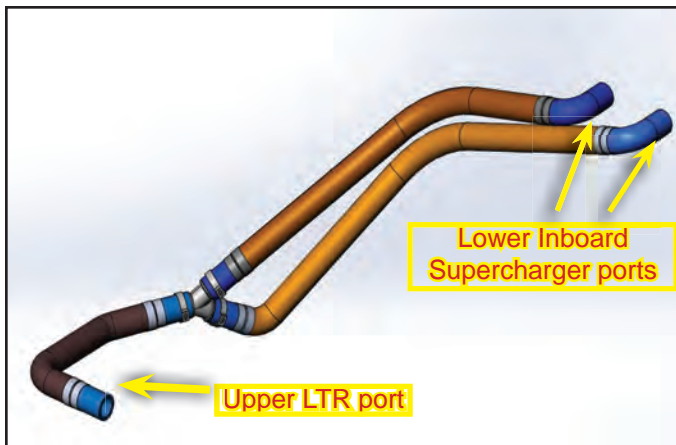

228. Attach the provided overflow hose to the overflow barb on the top of the LTR (shown with an arrow), securing in place with a provided spring clamp. Rotate the overflow barb so the hose runs in the direction shown.



229. Slide the Upper LTR to Supercharger hose from the inside through to the upper LTR port and connect using a clamp as shown at blue arrow. Also route the small hose attached to the LTR through the opening on the right side of the condenser, and the main radiator and place the end on the fuse box until the reservoir is installed.

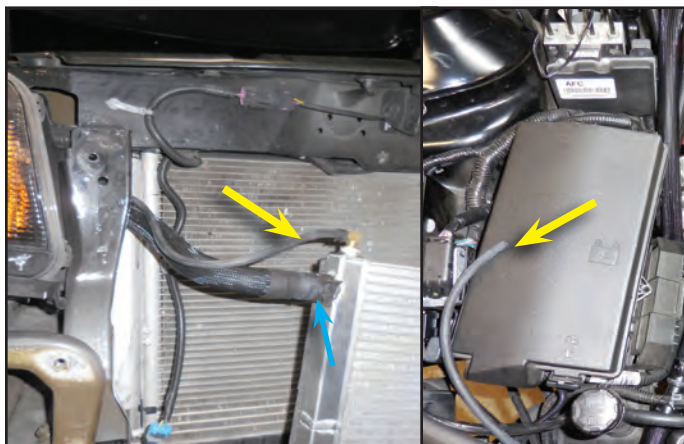

230. Connect the other ends of the LTR to Supercharger hose to the Lower Inboard ports with clamps shown with yellow arrows.



231. **This step is only for 2013-2015.** Install the provided grommets in the holes of the provided LTR mounting bracket. The grommet on the left is shown installed.

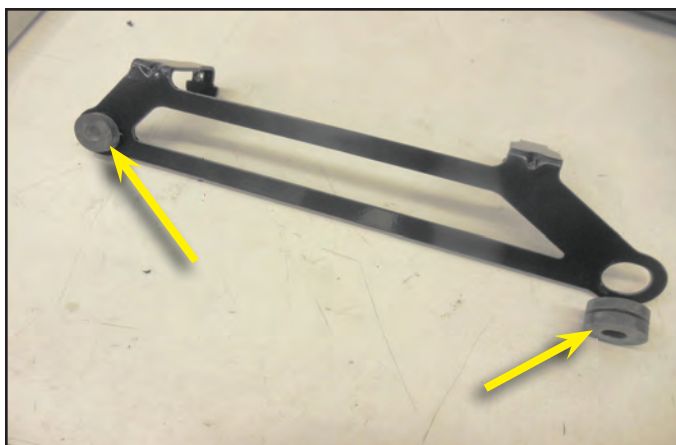

232. **This step is only for 2013-2015.**

Mount the provided LTR stabilizing bracket to the two existing tabs at the lower radiator mounting frame as shown, the flange with the grommets is oriented up and angled forward. Torque the provided mounting fasteners to 80 in-lbs. Be sure to incorporate the provided washers between the fastener head and plastic frame.

233. **This step is only for 2013-2015.**

Lower the LTR down in front of the radiator and press the bottom mounting tabs into the grommets of the LTR mounting bracket. The lower spigot of the LTR should pass through the hole/grommet of the vertical flange of the lower air deflector.

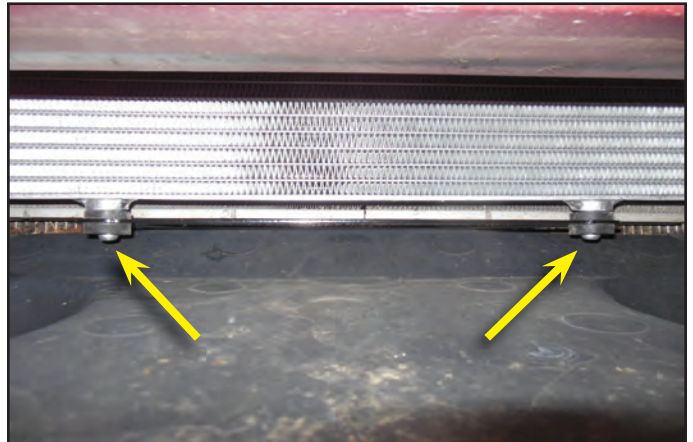
234. Connect the upper mounting bracket of the LTR to the cross frame with the provided bolts. **Torque these two bolts to 18 ft-lbs.**235. **This step is only for 2010-2012.**

Gather the following stabilizer brackets, rubber strips and self-tapping bolts. You will need to cut the rubber strips to fit in the brackets. First cut the smaller piece and stick it onto the bracket as shown in the center of the photo. Then cut and apply the larger piece of rubber so it looks like the completed bracket on the left.

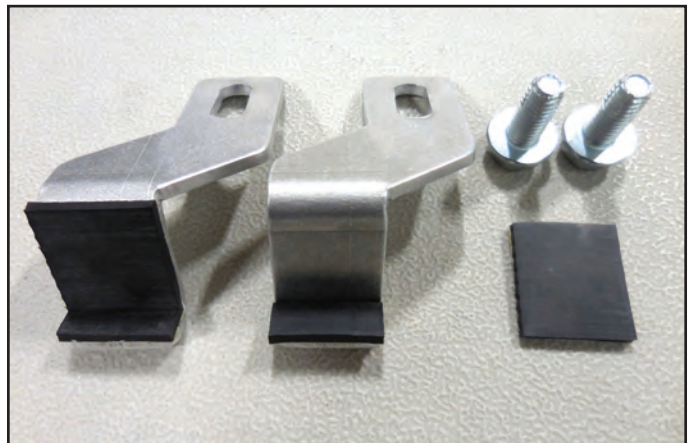

236. **This step is only for 2010-2012.**

Install the two stabilizer brackets at the bottom of the LTR, and secure with the self-tapping bolts in the two locations shown with arrows. Adjust the brackets so the rubber comes in contact with the bottom of the LTR. The two bolts should be snug.

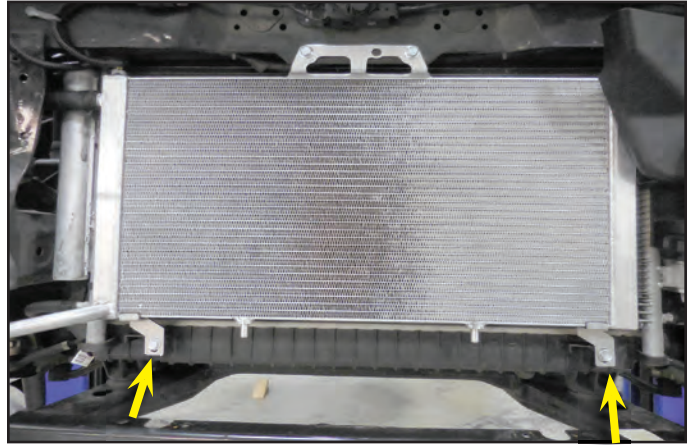

237. Gather the Reservoir to Intercooler Pump hose shown here.

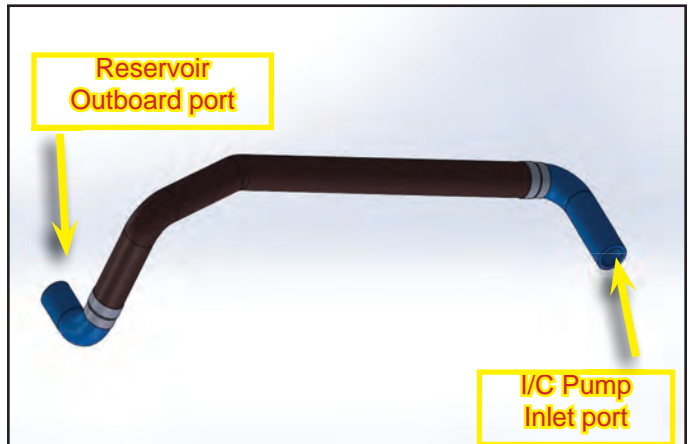

238. From the front of the vehicle on the right hand side, slide the long end of the hose with no fittings (Reservoir to Intercooler Pump hose) down to the inside of the splash shield between the vertical frame and radiator into the engine compartment with the end containing the short 90° elbow hose section at the top.



239. Rotate the upper end of that 90° elbow section into the engine compartment as well, below the radiator reservoir overflow tank hose and secure to the intercooler reservoir lower hose barb using a provided worm gear clamp. It's important to utilize only worm gear clamps on the reservoir plastic hose barbs.

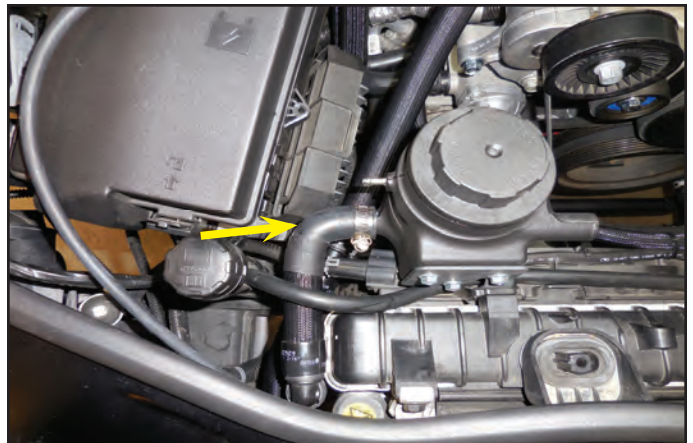



240. Connect the 90° elbow of the hose from the reservoir to the inlet hose barb on the intercooler pump and secure in position with a provided spring clamp.

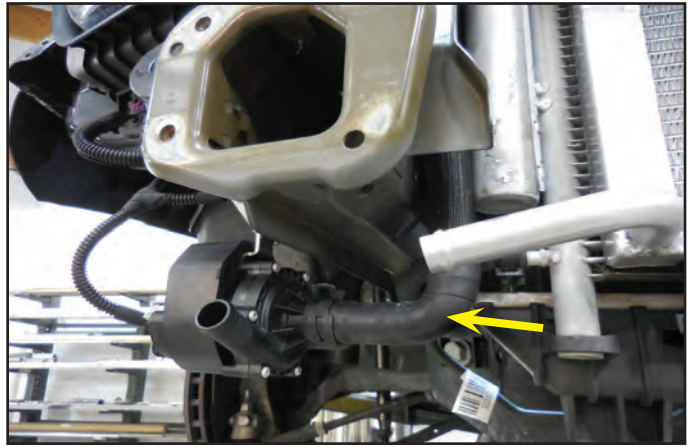

241. Connect the free end of the LTR overflow hose to the metal barb on the reservoir bottle (yellow arrow) using a provided spring clamp. You may need to trim the hose to route as shown, secure in place with a zip tie at the green arrow location.

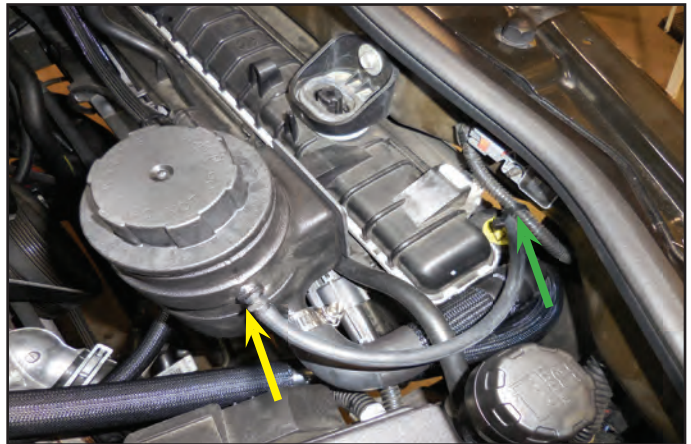

242. Gather the provided Supercharger to Reservoir intercooler hose assembly.

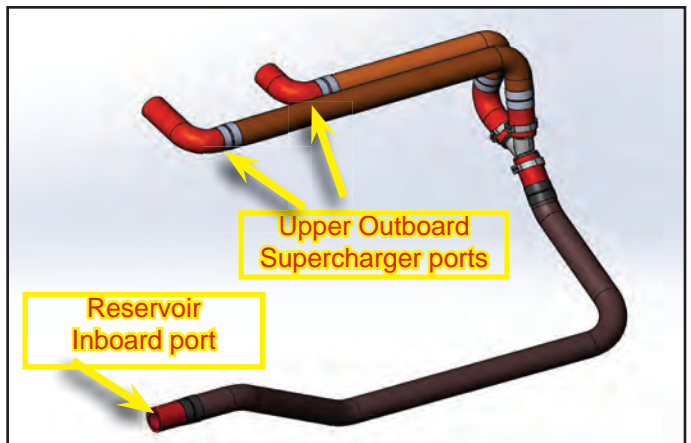

243. Connect the end of the “Reservoir to Supercharger” hose without the fitting to the upper (inside) hose barb on the reservoir using a provided worm gear clamp. Again, it’s important to utilize only worm gear clamps on the reservoir plastic hose barbs. Connect the fitting to the lower hose barb on the CAC manifold, again ensure the hose clamp snaps into position securely.

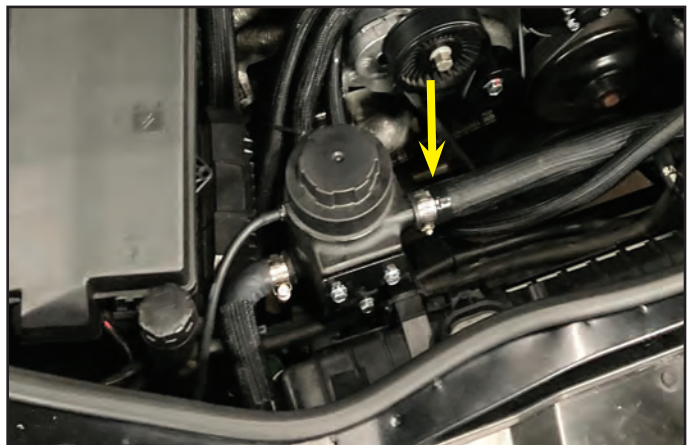

244. Attach the other two ends of the Reservoir to Supercharger hose to the Upper Outboard ports using clamps as shown.

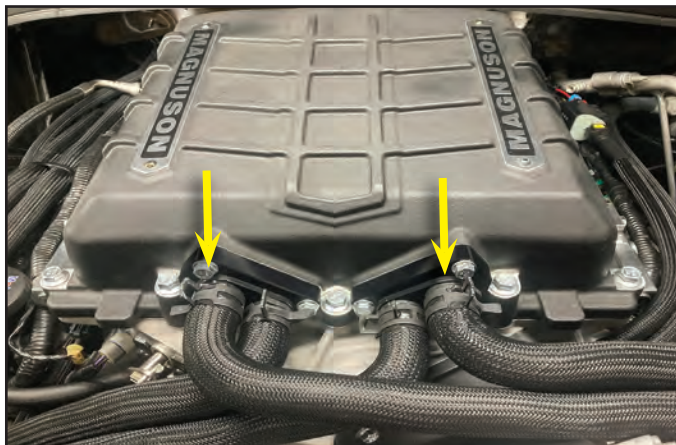

245. Trim a rectangular section of the right radiator duct that was removed earlier using the following dimensions.



246. Trim the yellow highlighted area away from the right radiator duct as well using these dimensions.

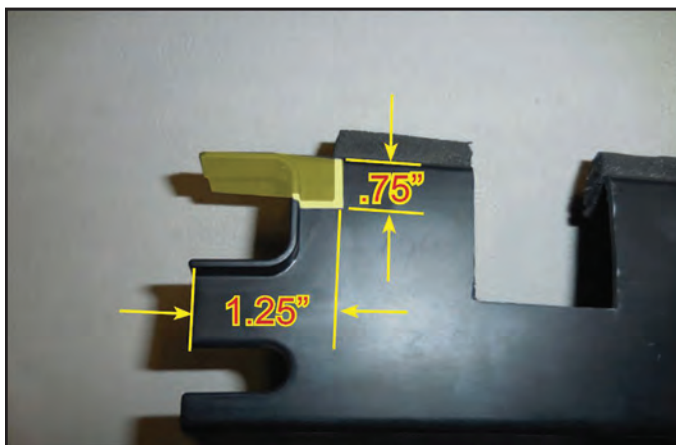

247. On the left radiator duct you will need to trim the yellow highlighted section away to make room for the LTR. Follow the dimensions shown.

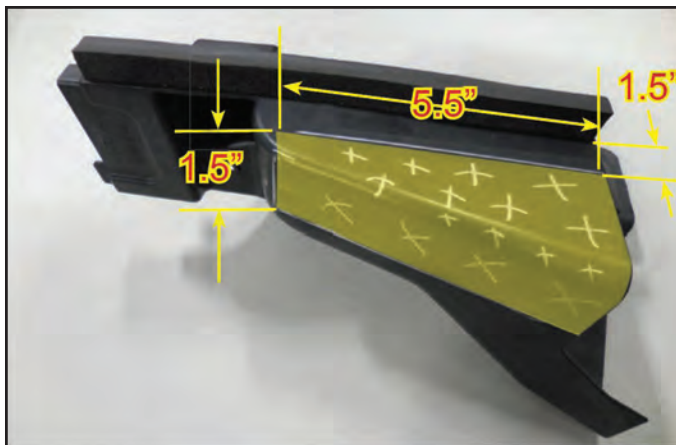

248. Drill a 1.5" diameter hole in the lower radiator duct near the temperature sensor mount following the dimensions shown. Deburr the hole and place the provided grommet in this location.

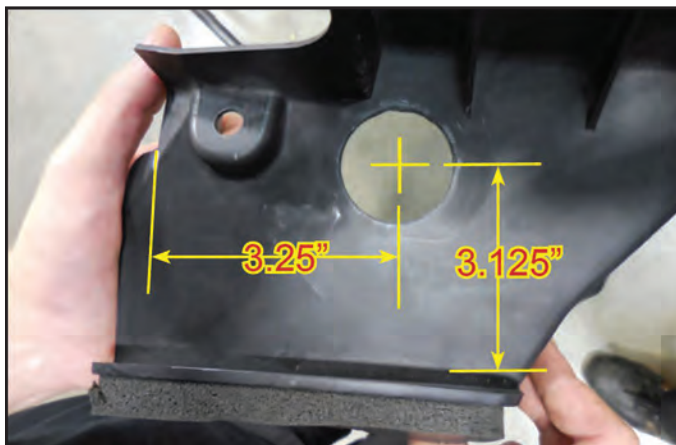

249. Remove the small highlighted area near the temperature sensor mount. This cut is approximately .75" x .75".

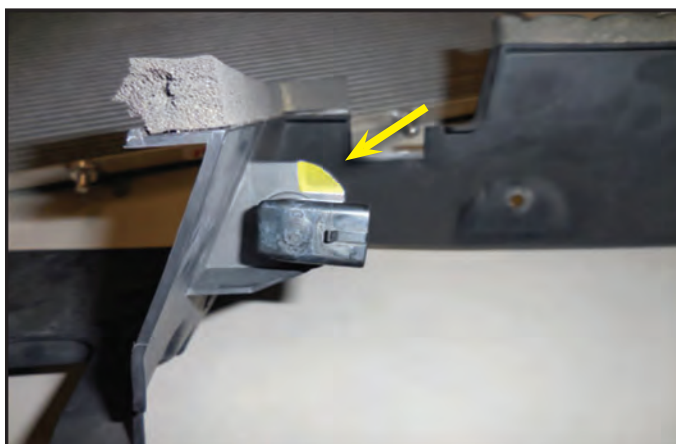

250. Rotate the lower duct with the 1.5" hole into the position shown to allow the hose barb to be inserted through the hole.

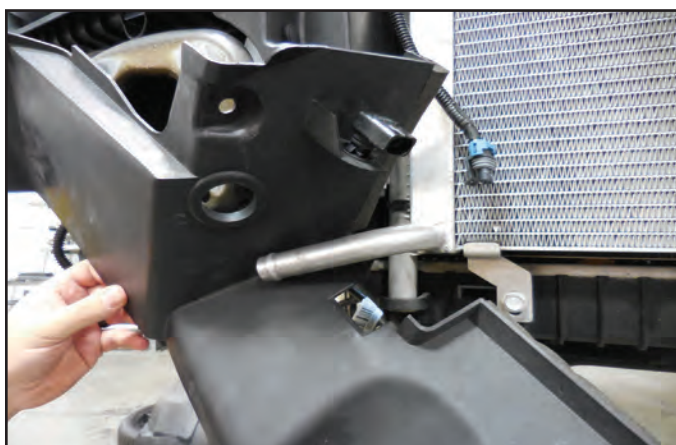

251. The hose barb is now inserted through the hole. Next re-connect the outside air temperature sensor to the right hand side air deflector.

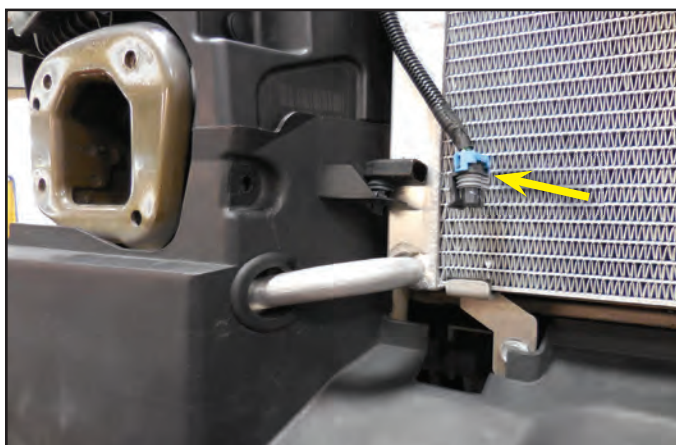

252. Gather the 90° Pump to LTR hose shown here.

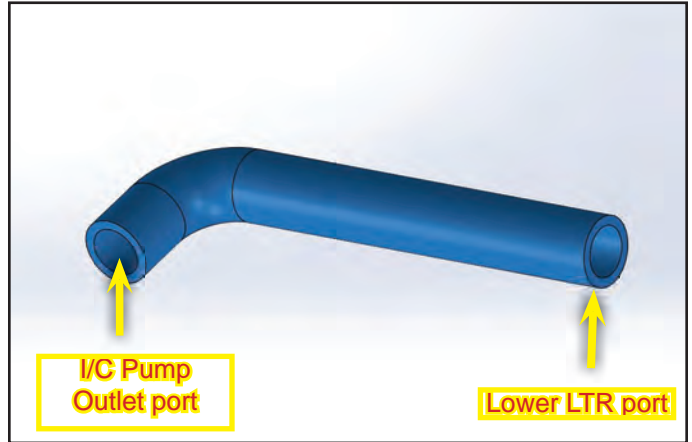

253. Connect the short end of the provided 6.5" by 2.5" length 90 degree hose to the intercooler pump discharge hose barb using a provided spring clamp. Route the long end of the hose to the lower LTR hose barb and secure with a provided spring clamp.

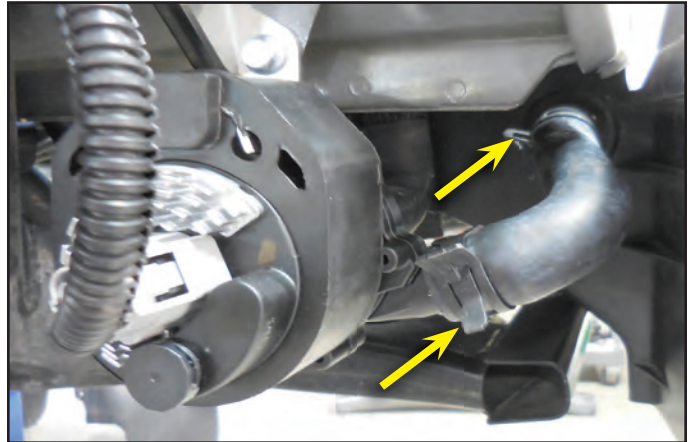

254. Re-install the left and right radiator ducts, and secure with the plastic rivets.



255. Mount the front bumper impact bar with the 6 OEM bolts using a 12 mm socket.  
**Torque these bolts to 22 ft-lbs.**



**DO NOT OVERTIGHTEN zip ties, they are to secure movement NOT COMPRESS.**

256. Use provided zip-ties to secure your hoses to adjacent components, making sure that hoses cannot migrate into moving components. Two locations are shown with arrows.

**DO NOT over tighten the zip ties.**



257. Verify that the OEM rubber isolators are in place and re-mount air box using OEM fasteners. Retain the adjacent hoses to the air box using zip ties to keep hoses off belt. (blue arrow)



258. Connect the MAF plug from the IAT breakout harness that you anchored to the radiator hose to the sensor on the air box throat. Connect the breakout harness plug to the OEM harness MAF plug connector.



259. Connect the provided inlet air tube. Secure in place with the provided worm gear hose clamps using an 8mm nut driver or flat head screwdriver.



260. Locate the 90° plastic fitting and install into the 30" long 1/4"ID hose that was connected to the RH valve cover port in earlier steps. Install other end of plastic fitting into air inlet tube.



261. Reconnect the battery negative terminal in the trunk and replace the associated covers reversing the removal steps.



**Make sure that you have followed step #1 in this manual to load the proper supercharger calibration to your vehicle's ECM.**



262. Ensure the petcock is closed prior to refilling the engine coolant. Place rags around the filler opening. Filter factory coolant that was drained in an earlier step and pour into the reservoir tank if it is reusable. Otherwise pour the new coolant mixed according to the manufacturer's specifications. Squeeze the radiator hoses to help relieve air in system. Install the cap once the coolant reservoir has been filled. You may need to top it off after the engine has run for the first time.



**\*\*\*WARNING: You must perform a vacuum leak down test on your intercooler system prior to adding any coolant. This can be accomplished with the same equipment that is used for engine cooling systems.\*\*\***

263. Un-bolt the three bolts holding the intercooler reservoir to the mounting bracket and lift the bottle so that it rests on the top edge of the bracket.



264. With the bottle in the lifted position, carefully fill your intercooler system with the GM recommended coolant mixture. To check for leaks prior to re-installing fascia/grille, temporarily reconnect the battery and key the car to "Accessory" position.

**DO NOT START. \* NOTE: The pump will slowly spool up once it has power. It may take 5-10 seconds before you notice flow.**



265. Re-mount your bottle using the three bolts supplied.

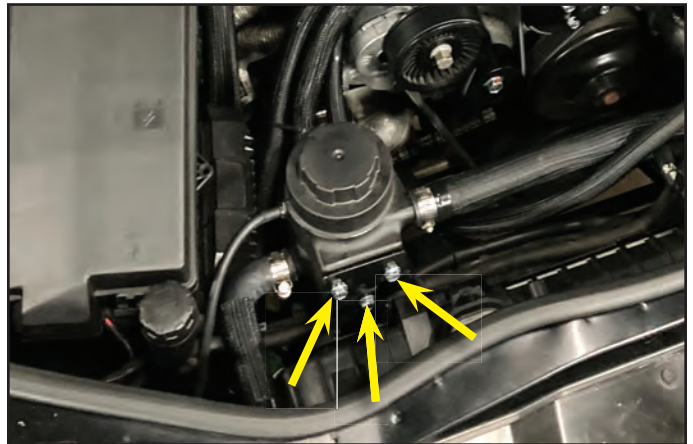

## Section 14: Body Panel Installation, and Final Inspection

266. Reinstall the fascia/grille components reversing the removal process using the OEM fasteners.



267. Reinstall the wheel well liners using the factory fasteners.



268. Torque wheels after installation.

**Refer to the owners manual for proper torque order and specifications under Vehicle Care, and Technical Data sections.**



269. Start your engine checking for leaks and listening for any unusual sounds or vibrations. There will be a slight whining as the rotors spin. This is a normal sound. Listen for any knocking or pinging (detonation). This vehicle requires 91 octane gasoline fuel and any residual lower octane fuel can create detonation. Run your engine for 5 minutes and shut down.



270. Let the engine cool down and check your intercooler, and radiator reservoir and top off as necessary.

**NOTE: Remember to unbolt and raise intercooler reservoir before checking to avoid spills and/or letting air pockets into the system.**



271. Affix the octane requirement fuel sticker to the inside of the fuel door as reference.





272. Test drive vehicle for the first few miles under normal driving conditions. **Do not perform any wide open throttle runs.** Listen for any noises, vibrations, engine misfire or anything that does not seem normal. The supercharger does have a slight whining noise under boost conditions, which is normal.



273. Check & bleed the charge air cooler reservoir as needed. After the initial test drive gradually work the vehicle to wide open throttle runs, listen for any engine detonation (pinging). If engine detonation is present let up on the throttle immediately. Most detonation causes are low octane gasoline still in the tank.



**\* Use only premium gasoline fuel, 91 octane or better. \***

**After you finish your installation and road test your vehicle, please fill out the warranty registration. This can be found on our website.**

If you have questions about your vehicles performance, please check with your installation facility.

### Appendix

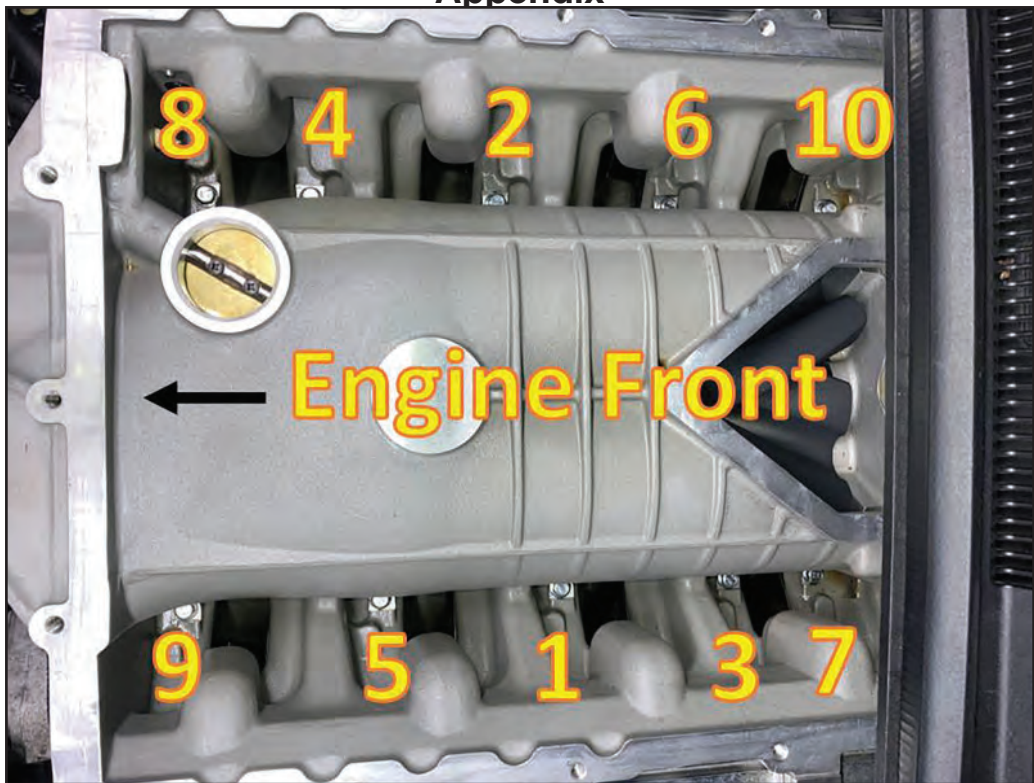

**Supercharger Torque Sequence  
(108 in-lbs Final Torque)**

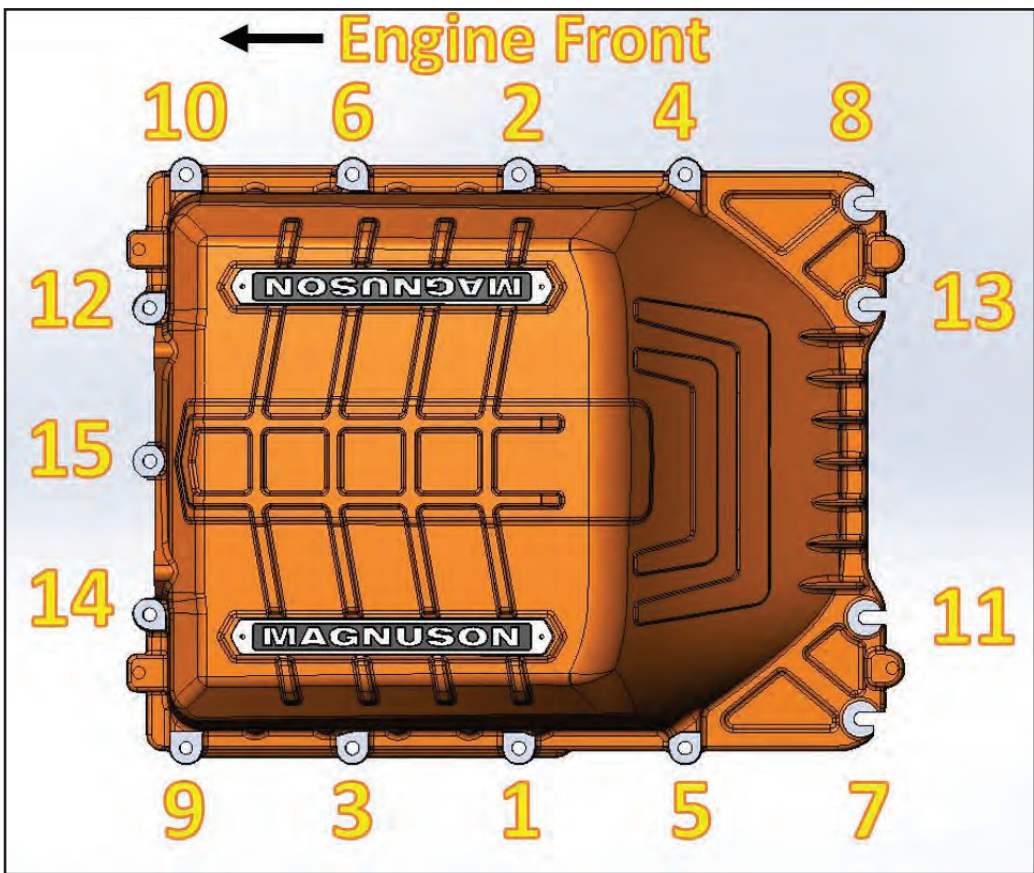

**Lid Torque Sequence  
(18 ft-lbs Final Torque)**

### Appendix

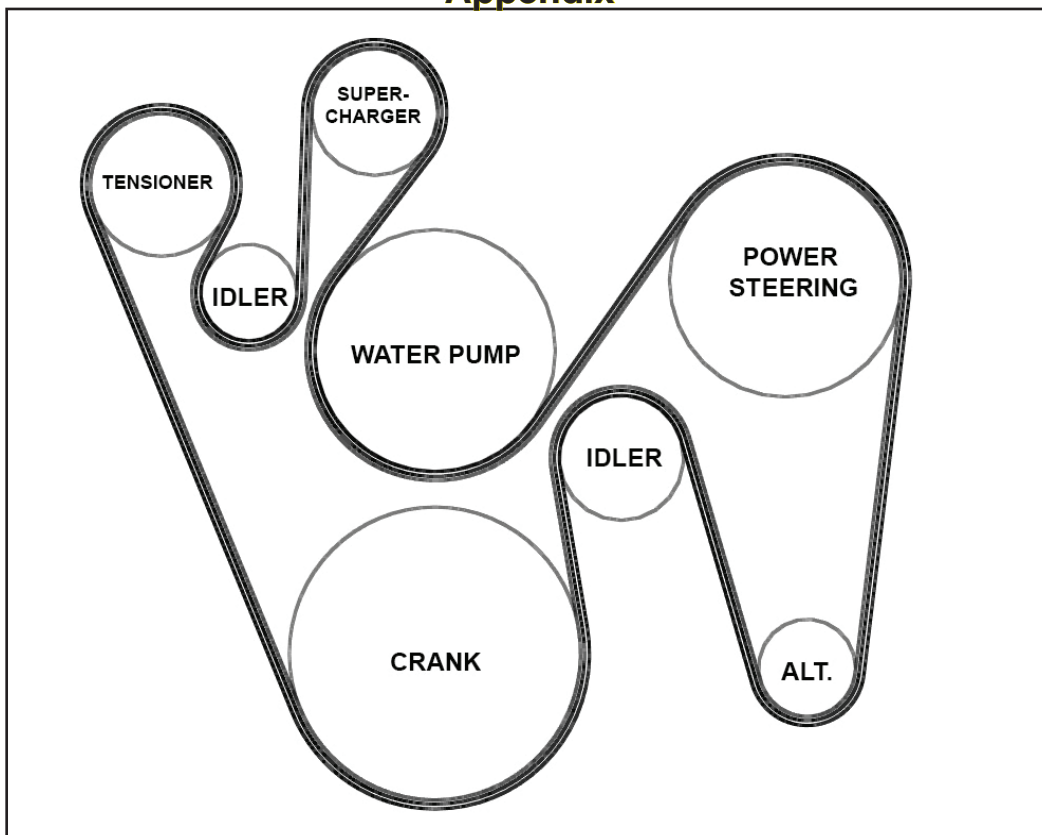

**2010-2012 Belt Routing Diagram**

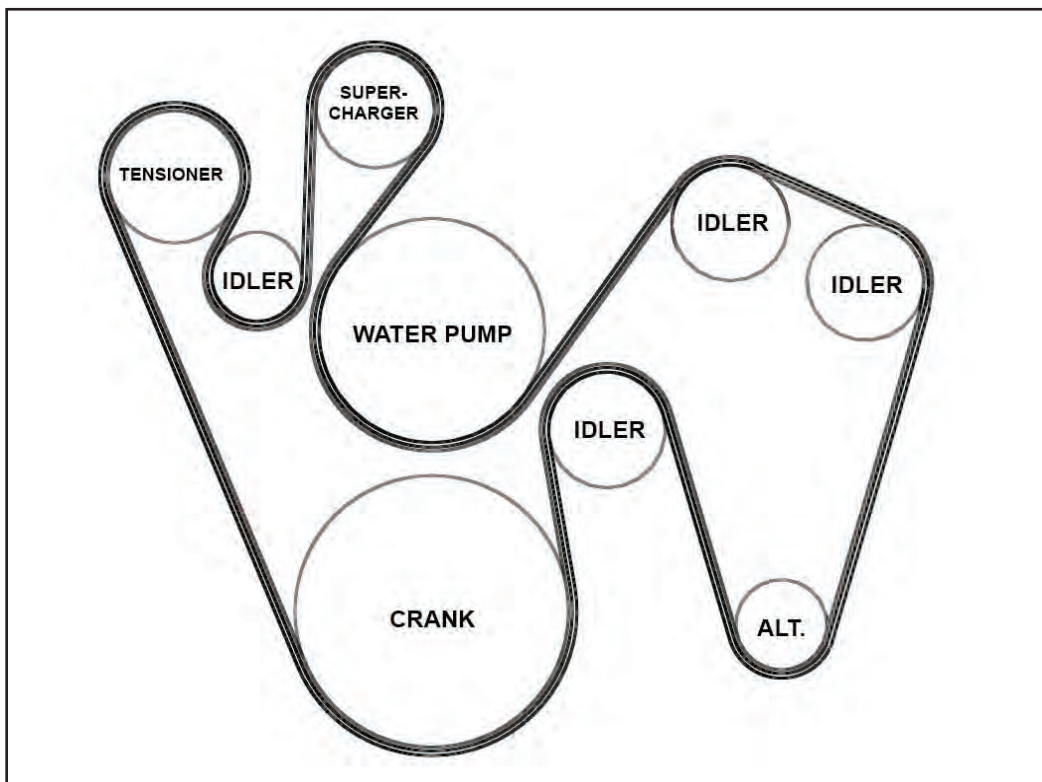

**2013-2015 Belt Routing Diagram**



Please enjoy your Magnuson Supercharged performance responsibly.

***This supercharger system requires the use of only premium gasoline fuel, 91 octane or better. The use of non-premium fuel can cause engine failure and will void your warranty. It is NOT compatible with E85, Ethanol, or Flex fuels.***

***NOTE: Your supercharger system is sensitive to corrosion. You must use the GM specified coolant mixture in the intercooler system as well as your radiator.***

**MAGNUSON**  
SUPERCHARGERS